

* Some of the contents in this manual may differ from your phone, depending on the software installed or your service provider.

SAMSUNG

**GPRS
GSM TELEPHONE
SGH-Q200**

SAMSUNG

ELECTRONICS

GPRS

World Wide Web
<http://www.samsungmobile.com>

Printed in Korea
Code No.: GH68-02528A
English.12/2001. Rev. 1.0



Contents

Important Safety Precautions	7
Unpacking	9
Your Phone	10
Phone Layout	10
Display	13
Service Light	16
Getting Started	17
Installing the SIM Card	17
Charging a Battery	19
Switching the Phone On/Off	21
Access Codes	22
General Functions	26
Making a Call	26
Adjusting the Volume	28
Answering a Call	29
Viewing Missed Calls	30
Selecting Functions and Options	32
Example: Setting the Display Language	34
Phonebook	36
Storing a Phone Number with a Name	36
Speed-Dialling by Memory Location	37
Searching for and Dialling a Number in the Phonebook	38
Phonebook Options	39
Entering Text	43
Changing the Text Input Mode	44
Using the T9 Mode	44
Using the Upper/Lower-Case Character Mode	46
Using the Number Mode	47

In-Call Options	48
Putting a Call on Hold	48
Switching the Microphone Off (Mute)	49
Muting/Sending Key Tones	50
Searching for a Number in the Phonebook	51
Using the SMS Service	52
Answering a Second Call	52
Making a Multiparty Call	53
Using the Menus	55
Accessing Menu Functions by Scrolling	55
Accessing Menu Functions by Using Shortcuts	56
Menu Map	57
Call Records	61
Missed Calls (<i>Menu 1.1</i>)	61
Received Calls (<i>Menu 1.2</i>)	61
Dialled Calls (<i>Menu 1.3</i>)	62
Call Time (<i>Menu 1.4</i>)	62
Call Cost (<i>Menu 1.5</i>)	63
Messages	64
Read Messages (<i>Menu 2.1</i>)	64
Write Messages (<i>Menu 2.2</i>)	66
Preset Message List (<i>Menu 2.3</i>)	66
Setup (<i>Menu 2.4</i>)	67
Broadcast (<i>Menu 2.5</i>)	68
Voice Mail (<i>Menu 2.6</i>)	70
Sound Settings	71
Ring Tone (<i>Menu 3.1</i>)	71
Melody Composer (<i>Menu 3.2</i>)	71
Ring Volume (<i>Menu 3.3</i>)	73
Alert Type (<i>Menu 3.4</i>)	74
Keypad Tone (<i>Menu 3.5</i>)	74
Message Tone (<i>Menu 3.6</i>)	75

Sound Settings (continued)	
Error Tone (<i>Menu 3.7</i>)	76
Minute Minder (<i>Menu 3.8</i>)	76
Connect Tone (<i>Menu 3.9</i>)	76
Phone Settings	77
Greeting Message (<i>Menu 4.1</i>)	77
Own Number (<i>Menu 4.2</i>)	77
Language (<i>Menu 4.3</i>)	78
Light (<i>Menu 4.4</i>)	78
Auto Redial (<i>Menu 4.5</i>)	79
Active Flip (<i>Menu 4.6</i>)	79
Anykey Answer (<i>Menu 4.7</i>)	80
Contrast (<i>Menu 4.8</i>)	80
Reset Settings (<i>Menu 4.9</i>)	80
Organiser	81
Calendar (<i>Menu 5.1</i>)	81
To Do List (<i>Menu 5.2</i>)	83
Time & Date (<i>Menu 5.3</i>)	86
Alarm (<i>Menu 5.4</i>)	87
Calculator (<i>Menu 5.5</i>)	89
ShortCut (<i>Menu 5.6</i>)	90
Security	91
PIN Check (<i>Menu 6.1</i>)	91
Change PIN (<i>Menu 6.2</i>)	92
Phone Lock (<i>Menu 6.3</i>)	92
Change Password (<i>Menu 6.4</i>)	93
SIM Lock (<i>Menu 6.5</i>)	93
FDN Mode (<i>Menu 6.6</i>)	94
Change PIN2 (<i>Menu 6.7</i>)	94

Network Services	95
Call Diverting (<i>Menu 7.1</i>)	95
Call Barring (<i>Menu 7.2</i>)	97
Call Waiting (<i>Menu 7.3</i>)	99
Network Selection (<i>Menu 7.4</i>)	100
Caller ID (<i>Menu 7.5</i>)	101
Closed User Group (CUG) (<i>Menu 7.6</i>)	101
Games	103
WAP Browser	105
Data Communication	105
Solving Problems	106
Using the Batteries	109
Precautions When Using Batteries	109
Safety Information	111
Road Safety	111
Operating Environment	111
Care and Maintenance	113
Emergency Calls	114
Glossary of Terms	115
Index	119
Quick Reference Card	123

Important Safety Precautions

Read these simple guidelines. Failure to comply with them may be dangerous or illegal.

For more detailed safety information, see Safety Information on page 111.

Road safety comes first

Do not use a hand-held phone while driving; park the vehicle first. Remember that in some countries, it is illegal to use a hand-held phone while driving.

Switch off when refuelling

Do not use the phone at a refuelling point (service station) or near fuels or chemicals.

Switch off in aircraft

Mobile phones can cause interference. Using them on aircraft is both illegal and dangerous.

Respect special regulations

Follow any special regulations in force in any area and always switch off your phone whenever it is forbidden to use it, or when it may cause interference or danger (in a hospital for example).

Interference

All mobile phones may be subject to radio interference, which may affect their performance.



Qualified service

Only qualified service personnel must repair cellular equipment. Use only approved accessories and batteries.

Use sensibly

Use only in the normal position (held to the ear). Avoid unnecessary contact with the antenna when the phone is switched on.

Emergency calls

Ensure that the phone is switched on and in service. Enter the emergency number (112 or another official emergency number) and press the  key. Give your location. Do not end the call until given permission to do so. End the call by closing the flip cover or pressing the  key.

IMPORTANT! Use only SAMSUNG-approved accessories.

The use of any other power accessory may invalidate any approval or warranty applying to the phone, and could be dangerous.

When you disconnect the power cord of any accessory, grasp and pull the connector, not the cord.

Unpacking

Your package contains the following items.

Handset



Travel Adapter

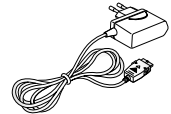

Battery



User's Manuals



Earphone



Data Cable

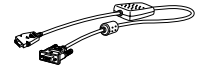

Software CD-ROM

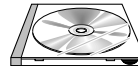

In addition, you can obtain the following accessories for your phone from your local SAMSUNG dealer:

- Desktop charger
- Cigarette lighter adapter
- Travel adapter
- Earphone
- Hands-free kit
- Car holder
- Slim and standard batteries

Your Phone

Phone Layout

The following illustrations show the main elements of your phone.

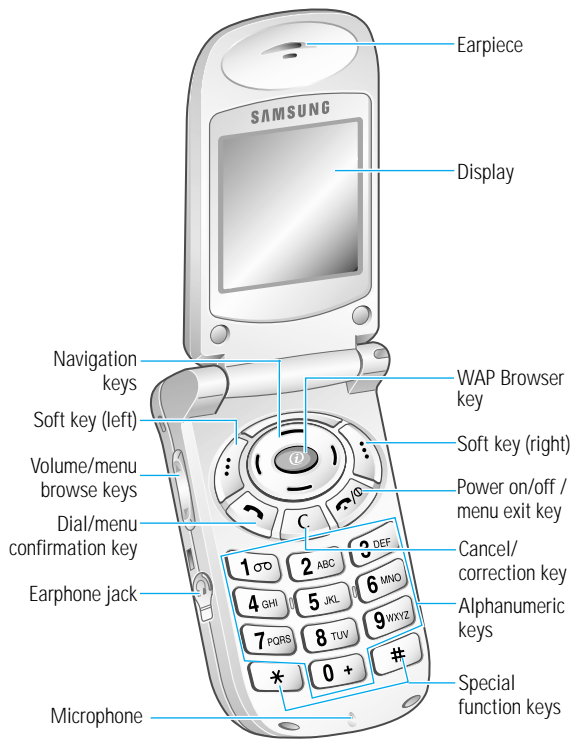

With the phone closed

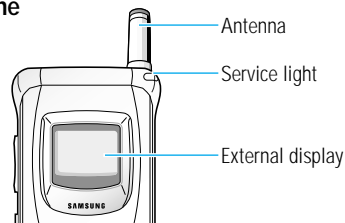

Key Description



(soft keys)

Perform the functions indicated by the text above them (in the bottom line of the display).



In the menu facility, scrolls through the menu options and phonebook memory.
When held down in idle mode, access your favourite menu options directly (for more information on shortcuts, see page 90).





In the menu facility, return to the previous menu level and select the current menu respectively.
When entering a name, move the cursor left and right respectively.
When pressed in idle mode, accesses your favourite menu options directly (for more information on shortcuts, see page 90).



Makes or answers a call.
In idle mode, recalls the last number dialled.
In the menu facility, selects a menu function or stores information that you have entered (such as a name) in the phone or SIM memory.

Key Description *(continued)*

 Deletes characters from the display.
In the menu facility, returns to the previous menu level.
When held down for more than two seconds in idle mode, accesses one of your favourite menu options directly (for more information on shortcuts, see page 90).

 Ends a call. Also switches the phone on and off when pressed and held.
In the menu facility, returns to the idle mode and cancels your input.

 Allows you to access quickly the Voice Mail menu.

 Enter numbers, letters and some special characters.



 Enter special characters.



 Allows you to access quickly the WAP Browser menu.

 (on the side of the phone)
During a call, adjust the earpiece volume.
With the flip cover open, adjust the key volume in idle mode, and backlight the display when held down in Phone Lock mode.
In the menu facility, scroll through the menu options and phonebook memory.

Display





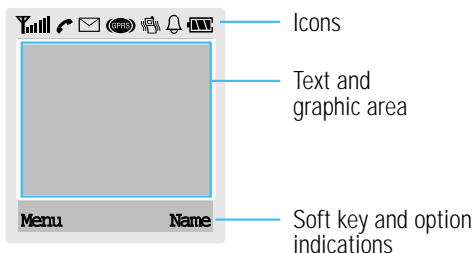





Display Layout

The display comprises three areas.



Area	Description
First line	Displays various icons (see page 14).
Middle lines	Display messages, instructions and any information that you enter (number to be dialled, for example).
Last line	Shows the functions currently assigned to the two soft keys and any options currently set (Mute for example).

Icons

Icon	Description
	Shows the received signal strength. The greater the number of bars, the better the signal strength.
	Appears when a call is in progress.
	Appears when a new text message has been received.
	Appears when you connect to the GPRS network.
	Appears when the Vibrate mode is active.
	Appears when you set the alarm.
	Shows the level of your battery. The more bars you see, the more power you have left.
	Appears when a new voice mail message has been received.
	Appears when you are out of your home area and have registered with a different network (when travelling in other countries, for example).
	Appears in the bottom line of the display when you activate the Mute mode.

Backlight

The display is illuminated by a backlight. When you press any key, the backlight illuminates. It turns off if no key is pressed within a given period of time, depending on the **Back Light** option in the **Phone Settings** menu.

To specify the length of time for which the backlight is active, set the **Back Light** menu option (**4.4.1**); see page 78 for further details.

External Display

Your phone has an external display on the cover. It indicates that you have an incoming call or a message, and notifies you at the specified time when you have set an alarm.

When you press and hold down the volume keys on the left side of the phone with the phone closed, the backlight of the external display illuminates.

Service Light

The service light is in the top right-hand corner of the phone. It flashes when services are available on the phone.

To activate or deactivate use of the service light, set the **Service Light** menu option (4.4.2); see page 78 for further details.

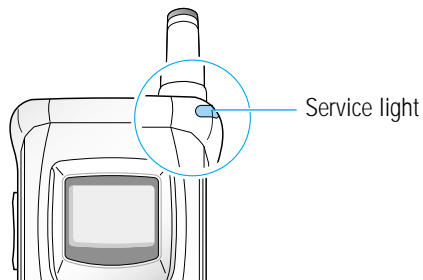

Getting Started

Installing the SIM Card

When you subscribe to a cellular network, you are provided with a plug-in SIM card loaded with your subscription details (PIN, optional services available and so on).

Important! The plug-in SIM card and its contacts can be easily damaged by scratches or bending, so be careful when handling, inserting or removing the card.

Keep all SIM cards out of the reach of small children.

1. If necessary, switch off the phone by holding down the  key until the closing animation is displayed.
2. Remove the battery. To do so:
 - ① Press and hold down the catch above the battery on the back of the phone.
 - ② Slide the battery away, as shown.

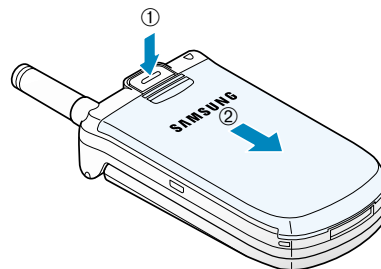

3. Insert the SIM card under the two tabs of the SIM card holder and slide it into the holder so that the holder locks the card in position, ensuring the cut corner is top left and the gold contacts of the card face into the phone.

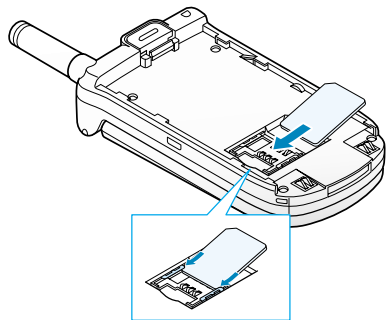

4. Place the battery back on the phone. Slide the battery up towards the catch until it clicks into place. Make sure that the battery is properly installed before switching on the power.

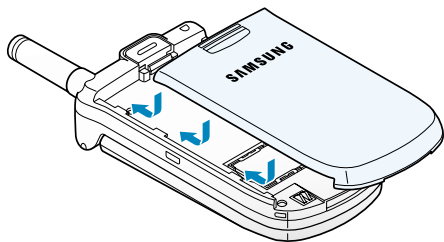

Charging a Battery

Your phone is powered by a rechargeable Li-ion battery. A travel adapter is provided with your phone. Use only approved batteries and chargers. Ask your local SAMSUNG dealer for further details.

The phone can be used while the battery is charging.

Note: You must fully charge the battery before using your phone for the first time. A discharged battery is fully recharged in approximately 200 minutes.

1. With the battery in position on the phone, connect the lead from the travel adapter to the bottom of the phone. Check that the arrow on the lead connector is facing towards the front of the phone.

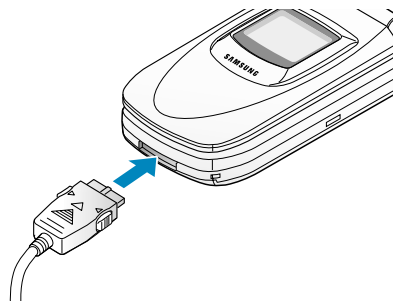

2. Connect the adapter to a standard AC wall outlet.

- When charging is finished, disconnect the adapter from the power outlet and from the phone by pressing the gray tabs on both sides of the connector and pulling the connector out.

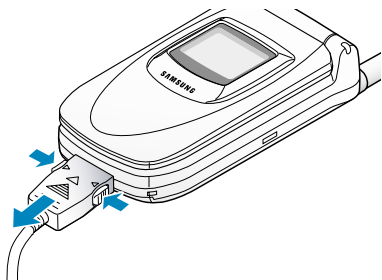

Low Battery Indicator

When the battery is weak and only a few minutes of talk time remain, you will hear a warning tone and a message will be repeated at regular intervals on the display:



When the battery becomes too weak for the phone to operate, the phone switches off automatically.

Switching the Phone On/Off

- Open the flip cover.
- Hold down the  key for more than one second to switch the phone on.
- If the phone asks for a password, key in the password and press the **OK** soft key. The phone password is factory set to 00000000. For further details, see page 22.
- If the phone asks for a PIN, key in the PIN and press the **OK** soft key. For further details, see page 23. The phone searches for your network and when it finds it, the idle screen, illustrated below, is displayed. The external display shows the signal strength, battery strength and current time and date.

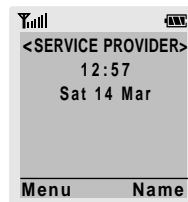

Note: The display language is factory set to English. To change the language, use the **Language** menu option (4.3); for further details, refer to page 78.

- When you wish to switch the phone off, hold down the  key for more than two seconds.

Access Codes

There are several access codes that are used by your phone and its SIM card. These codes help you protect the phone against unauthorised use.

When requested for any of the codes explained below, key in the appropriate code (displayed as asterisks) and press the **OK** soft key. If you make a mistake, press the **C** key one or more times until the incorrect digit is cleared and then continue entering the correct code.

The access codes (except for the PUK and PUK2 codes) can be changed using **Security** menu options. See page 91 for further details.

Important! Avoid using access codes resembling emergency numbers, such as 112, so that you do not dial an emergency number accidentally.

Phone Password

The Phone Lock feature uses the phone password to protect your phone against unauthorised use. The phone password is supplied with the phone and is factory set to 00000000.

To...	Refer to page...
Activate/deactivate the Phone Lock feature	92 (menu option 6.3).
Change the phone password	93 (menu option 6.4).

PIN

The **Personal Identification Number** or PIN (4 to 8 digits) protects your SIM card against unauthorised use. It is usually supplied with the SIM card.

If you enter an incorrect PIN three times in succession, the code is disabled and cannot be used until you re-enable it by entering the PUK (see below).

To...	Refer to page...
Activate/deactivate the PIN Check feature	91 (menu option 6.1).
Change the PIN	92 (menu option 6.2).

PUK

The 8-digit PUK (**P**ersonal **U**nblocking **K**ey) is required to change a disabled PIN. The PUK may be supplied with the SIM card. If not, or you have lost it, contact your service provider.

To re-enable your PIN, proceed as follows.

1. Key in the PUK and press the **OK** soft key.
2. Enter a new PIN of your choice and press the **OK** soft key.
3. When the **Confirm New PIN** message is displayed, key in the same code again and press the **OK** soft key.

If you enter an incorrect PUK ten times in succession, the SIM card becomes invalid. Contact your service provider for a new card.

PIN2

The PIN2 (4 to 8 digits), supplied with some SIM cards, is required to access specific functions, such as setting the maximum cost of a call. These functions are available if supported by your SIM card.

If you enter an incorrect PIN2 three times in succession, the code is disabled and you cannot access the functions until you re-enable it by entering the PUK2.

To change the PIN2, refer to page 94 (menu option **6.7**).

PUK2

The 8-digit PUK2 (**P**ersonal **U**nblocking **K**ey **2**), supplied with some SIM cards, is required to change a disabled PIN2. If you lose the code, contact your service provider.

To re-enable your PIN2, proceed as follows.

1. Key in the PUK2 and press the **OK** soft key.
2. Enter a new PIN2 of your choice and press the **OK** soft key.
3. When the **Confirm PIN2** message is displayed, key in the same code again and press the **OK** soft key.

If you enter an incorrect PUK2 ten times in succession, you will not be able to access the functions requiring the PIN2. Contact your service provider for a new card.

Barring Password

The 4-digit barring password is required when you use the Call Barring function. You obtain the password from your service provider when you subscribe to this function. See page 98 for further details.

General Functions

Making a Call

When the idle screen is displayed, key in the area code and phone number and press the  key.

Note: If you have set the **Auto Redial** menu option (4.5) to **ON** (see page 79) and the person called does not answer or is already on the phone, the number is redialled automatically up to ten times.

Making International Calls

1. Press and hold down the **0** key.
The + character appears.
2. Key in the country code, area code and phone number and press the  key.

Correcting the Number

To clear...	Then...
The last digit displayed	Press the C key.
Any other digit in the number	Press the (or) key until the cursor is immediately to the right of the digit to be cleared. Press the C key. You can also insert a missing digit simply by pressing the appropriate key.
The whole display	Hold down the C key for more than one second.

Ending a Call



When you have finished your call, briefly press the /☎ key.

Making a Call from the Phonebook

You can store the names and phone numbers dialled regularly in the SIM card and phone memory, called the phonebook. You then simply select the required name to recall the associated number. For further details on the Phonebook feature, refer to page 36.

Redialling the Last Number

The phone stores the last 10 numbers dialled. To recall any of these numbers, proceed as follows.

1. Press the  key to display a list of the last numbers dialled.
2. Use the  and  keys to scroll through the numbers until the required number is highlighted.
3. **To...** **Then...**

Dial the number highlighted	Press the  key.
Edit the number highlighted	<ul style="list-style-type: none"> • Press the Edit soft key. • Change the number as required, referring to Correcting the Number on the previous page for further details.

Adjusting the Volume

During a call, if you want to adjust the earpiece volume, use the ▲ and ▼ keys on the left side of the phone.

Press ▲ to increase and ▼ to decrease the volume.



In idle mode with the flip cover open, you can adjust the key volume using the ▲ and ▼ keys.

Answering a Call

When somebody calls you, the phone rings and the phone icon in the middle of the screen flashes.

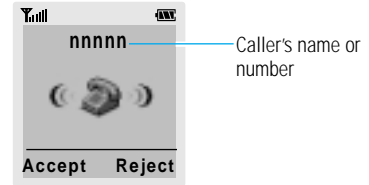

If the caller can be identified, the caller's phone number (or name if stored in your phonebook) is displayed. If the caller cannot be identified, only the phone icon flashes.

1. If necessary, open the flip. Press the  key or the **Accept** soft key to answer the incoming call.

If the **Anykey Answer** menu option (4.7) is set to **ON**, you can press any key to answer a call except for the  key and the **Reject** soft key (see page 80).

Notes:

- To reject an incoming call, press the **Reject** soft key.
- If the **Active Flip** menu option (4.6) is set to **Enable**, you do not need to press any key. You can answer the call simply by opening the flip (see page 79).

2. End the call by closing the phone or pressing the  key.

Note: You can answer a call while using the phonebook or menu features.

Viewing Missed Calls



If you are unable to answer a call for any reason, you can find out who was calling you, provided that this service is available. In this way, you can call the person back, if necessary.

The number of missed calls is displayed on the idle screen immediately after a call was missed.

To view the missed call immediately, proceed as follows.



1. If the phone is closed, press the **View** soft key or open the flip cover. If the flip cover is already open, press the **View** soft key.

The number corresponding to the most recent missed call is displayed, if available.

- | | |
|-------------------------------------|---|
| 2. To... | Then press the... |
| Scroll through the missed calls |  and  keys. |
| Call the number displayed |  key. |
| Edit or delete a missed call number | Select soft key (see next page). |



Editing a Missed Call Number

Note: If the number corresponding to the missed call is not available, the **Edit Number** option is not displayed.

1. Press the **Options** soft key.
2. If necessary, press the  or  key to highlight the **Edit Number** option.
3. Press the **Select** soft key.
4. Change the number as required.

- | | |
|------------------|--|
| 5. To... | Then press the... |
| Call the number |  key. |
| Store the number | Save soft key and enter the name and location required (for further details, refer to page 36). |

Deleting a Missed Call

1. Press the **Options** soft key.
2. If necessary, press the  or  key to highlight the **Delete** option.
3. Press the **Select** soft key.

You can press the  key at any time to exit the Missed Call feature.

Note: You can access the Missed Call feature at any time by selecting the **Missed Calls** menu option (1.1); for further details, see page 61.

Selecting Functions and Options

Your phone offers a set of functions that allow you to customise your phone. These functions are arranged in menus and sub-menus, accessed via the two soft keys (ⓘ and ⓘ). Each menu and sub-menu allows you to view and alter the settings of a particular function.

The roles of the soft keys vary according to the current context; the label on the bottom line of the display just above each key indicates its current role.

Example:

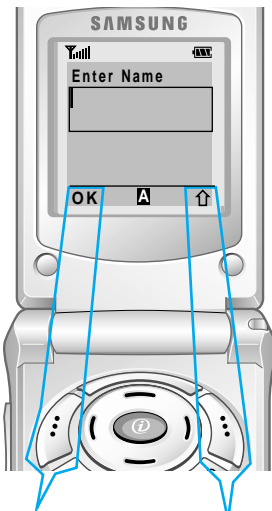

Press the left soft key to save the name entered.

Press the right soft key to change the text input mode.

To view the various functions/options available and select the one required, proceed as follows.

1. Press the appropriate soft key.

2. **To...**

Then press the...

Select the:

- Function displayed
- or
- Option highlighted

Select soft key or ⓘ key.

View the next function or highlight the next option in a list

— key or ▼ key on the left side of the phone.

Move back to the previous function or option in a list

— key or ▲ key on the left side of the phone.

Move back up one level in the structure

(key, ↵ soft key or C key.

Exit the structure without changing the settings

↶/⓪ key.

In some functions, you may be asked for a password or PIN. Enter the required code and press the **OK** soft key.

Note: When you access a list of options, your phone highlights the current option. If, however, there are only two options, such as On/Off or Enable/Disable, your phone highlights the option that is not currently active, so that you can select it directly.

Example: Setting the Display Language

1. When the idle screen is displayed, press the **Menu** soft key to enter the menu facility.

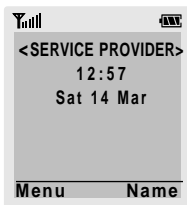

2. Scroll through the menus until you reach the **Phone Settings** menu, by pressing the **Left** and **Right** keys.



3. To select the **Phone Settings** menu, press the **Select** soft key or the **Right** key.

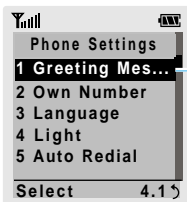

If the menu name is too long for the display, it is scrolled when highlighted.

4. Scroll through the sub-menus until you reach the **Language** sub-menu, by pressing the **Left** and **Right** keys.

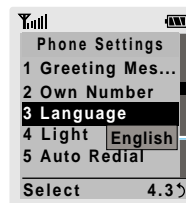

Shows the current setting

5. To view the languages available, press the **Select** soft key or the **Right** key. The current setting is highlighted.

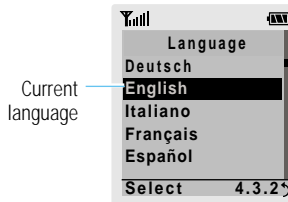

6. Scroll through the list of languages until the appropriate one is highlighted, by pressing the **Left** and **Right** keys.
7. Press the **Select** soft key or the **Right** key to confirm your selection.
8. Press the **C** or **Left** key twice to exit the menu structure.

Phonebook

You can store phone numbers and their corresponding names in the memory of your SIM card. In addition, you can store up to 99 numbers and names in the phone memory. The SIM card and phone memories, although physically separate, are used as if they were a single entity, called the phonebook.

Storing a Phone Number with a Name

As soon as you start to enter a number, **Save** appears above the left soft key to allow you to store the number in the phonebook.

1. Key in the number to be stored.
Note: If you make a mistake while entering a number, correct it using the **C** key. For further details, refer to page 26.
2. When you are sure that it is correct, press the **Save** soft key.
3. Enter the corresponding name (the maximum length depends on your SIM card). For information on how to enter a name, see page 43.
4. When you are satisfied, press the **OK** soft key. The phone now displays the first free location in the last memory used to save a number and name. If that memory is full, the first free location in the other memory is displayed.

5. Press the right soft key to toggle between the phone (**To Phone**) and card (**To Card**) memories.
6. If you do not want to save the number and name in the suggested location, press the **C** key to clear the location number and enter your preferred location by pressing the number keys.
7. Press **OK** to store the name and number.
8. Press  to return to the idle screen.

Speed-Dialling by Memory Location

Once you have stored phone numbers in the SIM card, you can dial them easily whenever you want.

To speed-dial a number, proceed as follows.

To speed-dial a number in locations...	Then...
2 to 9	Press and hold down the appropriate key.
10 and above	<ul style="list-style-type: none"> • Press the appropriate keys, followed by the # key. The display shows the name, phone number and location. • To dial the number, press the Dial soft key.

Note: Memory location 1 is reserved for your Voice Mail server number.

Searching for and Dialling a Number in the Phonebook

1. When the idle screen is displayed, press the **Name** soft key. You are asked to enter a name.
2. Enter the start of the name that you wish to find and press the **Search** soft key.

Note: You can also scroll through the phonebook from the beginning, by pressing the **Search** soft key directly.

The phonebook entries are listed, starting with the first entry matching your input. This entry is also highlighted.

- | | |
|--|---|
| 3. To... | Then press the... |
| View the highlighted entry | View soft key. |
| Select a different entry | ← or → key one or more times until the required entry is highlighted. |
| Look for a name starting with a different letter | Key labelled with the required letter. |
4. Once you have found the required entry, press the **↵** key to dial the number.

Phonebook Options

When storing or viewing a number in the phonebook, **Options** appears above the left soft key to allow you to access the phonebook options, described in the following paragraphs.

Accessing the Options

To access the various phonebook options, proceed as follows.

- | | |
|--|--|
| 1. Press the Options soft key. The first available option is highlighted. | |
| 2. To... | Then press the... |
| Select the highlighted option | Select soft key or ↵ key. |
| Highlight a different option | ← or → key one or more times until the required option is highlighted. |

Paste

This option allows you to paste the phonebook number into the normal dialling mode. Use this option to dial a number similar to one in the phonebook (a different extension in the same office for example).

Use the **C** key to change the number as required (refer to page 26 for further details). When you are ready to dial, press the **↵** key.

Edit

This option allows you to edit a number and name stored in the phonebook.

Erase

This option allows you to erase a number and name stored in the phonebook. You are asked to confirm that you wish to erase the name and number from the phonebook by pressing the **Yes** soft key.

Copy

This option allows you to copy a phonebook number to another location. Use this option to store a number similar to one already in memory; once copied, edit the number and store it in the phonebook.

Caller Group

You can set the phone to ring in a specific way and display a preselected graphic icon when a particular person calls you. To do so, you must:

- Define your caller groups
- Assign the numbers in the phonebook to the appropriate group

Defining a caller group

You can define up to five caller groups.

1. In the idle mode, press the **Name** soft key.
2. Press the **Options** soft key.

3. Select the **Caller group** option.
4. Select the group to be defined.
5. Set the appropriate options.

The following options are available.

Call ring tone: allows you to select the ring tone to be used when you receive a voice phone call from a person in the group.

SMS tone: allows you to select the ring tone to be used when you receive a text message from a person in the group.

Graphic: allows you to select the graphic icon to be displayed when you receive a call from a person in the group.

Group Name: allows you to assign a name to the group; for further details on how to enter characters, refer to page 43.

Assigning numbers to a group

1. View the required number in the phonebook.
2. Press the **Options** soft key.
3. Select the **Caller Group** option.
4. Select the required group.

To remove a number from a group, select the **No Group** option.

Memory Status

You can check how many names and numbers are stored in the phonebook (card and phone memories). Proceed as follows.

1. In the idle mode, press the **Name** soft key.
2. Press the **Options** soft key.
3. Select the **Memory Status** option.
4. Press **Next** to toggle between the card and phone memories.

SDN

You can view the list of Service Dialling Numbers (SDN) assigned by your network provider. Such numbers include the emergency, directory enquiries and voice mail numbers.

1. In the idle mode, press the **Name** soft key.
2. Press the **Options** soft key.
3. Select the **SDN** option.
4. Scroll through the numbers using the **←** and **→** keys.
5. To dial the number displayed, press the **Dial** soft key.

Note: This option is available only when your SIM card supports Service Dialling Numbers (SDN).

Entering Text

When using your phone, you will often need to enter text. For example, when storing a name in the phonebook, creating your personal greeting or scheduling events in your calendar. You can enter alphanumeric characters by using your phone's keypad.

You are provided with the following text input modes.

- **T9 mode**

This mode allows you to enter words with only one keystroke per letter. Each key on the keypad has more than one letter – when you press the **5** key once, J, K or L may be displayed. The T9 mode automatically compares your keystrokes with an internal linguistic dictionary to determine the correct word, thus requiring far fewer keystrokes than the traditional upper/lower-case character modes.

- **Upper/lower-case character modes**

These modes allow you to enter letters by pressing the key labelled with the required letter once, twice or three times until the letter is displayed.

- **Number mode**

This mode allows you to enter numbers.

Changing the Text Input Mode

When you are in a field that allows characters to be entered, you will notice the text input mode indicator in the display.

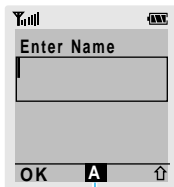

Text input mode indicator

To select...

Then press the **↑** soft key until...

- | | |
|-----------------------|--------------------------------------|
| Upper-case characters | A is displayed. See page 46. |
| Lower-case characters | a is displayed. See page 46. |
| Numbers only | 1 is displayed. See page 47. |
| The T9 mode | T9 is displayed. See page 44. |

Using the T9 Mode

The T9 predictive text input mode allows you to key in any character using single keystrokes. This text input mode is based on a built-in dictionary.

1. When you are in the T9 predictive text input mode, start entering a word by pressing keys **2** to **9**. Press each key only once for one letter.

Example: to enter *HELLO* in the T9 mode, press



The word that you are typing appears in the display. It may change with each key that you press.

2. Enter the whole word before editing or deleting or keystrokes.
3. If the word is correct, start entering the next word.

Otherwise, press **0**, **←** or **→** repeatedly to display alternate word choices for the keys that you have pressed.

Example: *OF* and *ME* both share the sequence **6, 3**. The phone displays the most commonly used choice first.

4. Complete each word with a space by pressing the **#** key.
 - To type words not found in the T9 mode, change the text input mode to the upper/lower-case character input mode.

- To enter full stops, hyphens or apostrophes, press the **1** key. The T9 mode applies grammar rules to ensure that the correct punctuation is used.

Example:  is used twice to display two punctuation marks:



- To change the case in the T9 mode, use the ***** key.
- You can move the cursor by using the **(** and **)** keys. To delete letters, press the **C** key. Press and hold down the **C** key to clear the display.

Using the Upper/Lower-Case Character Mode

Use the **1** to **9** keys to enter your text.

- Press the key labelled with the required letter:
 - Once for the first letter
 - Twice for the second letter
 - And so on
- Select the other letters in the same way.

Note: The cursor moves to the right when you press a different key. When entering the same letter twice (or a different letter on the same key), just wait for a few seconds for the cursor to move right automatically, and then select the next letter.

Refer to the table below for more information on the characters available using the keys.

Key	Characters in the Order Displayed	
	Upper Case	Lower Case
1	Space . 1 ! ? & i ; \$. % @ _ E \$ ¥ × \$
2	A B C 2 Ä Å Æ Ç Γ	a b c 2 à á â æ Γ
3	D E F 3 É Δ Φ	d e f 3 é é Φ
4	G H I 4 Θ Ψ	g h i 4 i Ψ
5	J K L 5 Λ	j k l 5 Λ
6	M N O 6 Ñ Ò Ó	m n o 6 ñ ò ó
7	P Q R S 7 Π Σ Ξ	p q r s 7 β Σ Ξ
8	T U V 8 Ü ü	t u v 8 ü ü
9	W X Y Z 9 Ω	w x y z 9 Ω
0	* # , ; ' " =	/ : - + () < >

- To insert a space, press the **#** key.
- You can move the cursor by using the **(** and **)** keys. To delete letters, press the **C** key. Press and hold down the **C** key to clear the display.

Using the Number Mode

The Number mode enables you to enter numbers in a text message (a telephone number for example). Press the keys corresponding to the required digits before manually switching back to the appropriate text entry mode.

In-Call Options

Your phone provides a number of control functions that you can use during a call.

Putting a Call on Hold

You can place the current call on hold whenever you want. You can make another call while you have a call in progress if this service is supported by the network. Of these two calls, one is active and the other is on hold and you can swap between the calls.

To place a call on hold, simply press the **Hold** soft key. You can reactivate the call whenever you want, by pressing the **Unhold** soft key.

To make a call while you have a call in progress, proceed as follows.

1. Key in the phone number that you wish to dial or look it up in the phonebook.
2. Press the  key to dial the second call. The first call is automatically put on hold.

Or alternatively, proceed as follows.

1. Put the current call on hold by pressing the **Hold** soft key.
2. Make the second call in the normal way.

To swap between the two calls, simply press the **Swap** soft key.

The current call is placed on hold and the call on hold is reactivated so that you can continue conversing with the other party.

When you have finished, end each call normally by pressing the /Ⓣ key.

Switching the Microphone Off (Mute)

You can temporarily switch your phone's microphone off, so that the other party cannot hear you.

Example: You wish to say something to another person in the room but do not want the other party to hear you.

To switch the microphone off temporarily, proceed as follows.

1. Press the **Options** soft key.
2. If necessary, press the  key to highlight the **Mute** option.
3. Press the **OK** soft key.

Your correspondent can no longer hear you.

To switch the microphone back on, proceed as follows.

1. Press the **Options** soft key.
2. If necessary, press the — key to highlight the **Unmute** option.
3. Press the **OK** soft key.

Your correspondent can hear you again.

Muting/Sending Key Tones

These options allow you to turn the key tones off or on. If the **Mute keys** option is selected, your phone does not transmit the key tones. It allows you to press keys without hearing annoying key tones during a call.

Note: To communicate with answering machines or computerised telephony systems, the **Send keys** option must be selected.

Searching for a Number in the Phonebook

You can search for a number in the phonebook during a call.

1. Press the **Options** soft key.
2. Press the **—** key to highlight the **Phonebook** option.
3. Press the **OK** soft key.
The phonebook entries are listed.
4. Enter the name that you wish to find.

If you enter the start of the name, the phonebook entries are listed, starting with the first entry matching your input. The entry is also highlighted.

5. To view the highlighted entry, press the **View** soft key.

For a more detailed description of the Phonebook feature, refer to page 36.

Using the SMS Service

If you receive an SMS (Short Message Service) message during a call, the message icon (✉) flashes in the display. The **SMS Service** option enables you to use this feature.

Read Messages: allows you to read the messages that you have received.

Write Messages: allows you to write a message.

For further details on the SMS service, refer to page 64.

Answering a Second Call

You can answer an incoming call while you have a call in progress, if this service is supported by the network and you have set the **Call Waiting** menu option (7.3) to **Activate** (see page 99). You will be notified of an incoming call by a call waiting tone.

To answer a call while you have a call in progress, proceed as follows.

1. Press the  key to answer the incoming call.
The first call is automatically put on hold.
2. To switch between the two calls, press the **Swap** soft key.

To end a held call, press the **Options** soft key and select the **End Held Call** option.

3. To end the current call, press the /Ⓚ key.

Making a Multiparty Call

A multiparty call is a network service that allows up to six people to take part simultaneously in a multiparty or conference call. For more information, contact your service provider.



Setting up the Multiparty Call

1. Call the first participant in the normal way.
2. Call the second participant in the normal way. The first call is automatically put on hold.
3. To join the first participant to the multiparty call, press the **Options** soft key and select the **Join** option.
4. To add a new person to the multiparty call, call the person in the normal way, then press the **Options** soft key and select the **Join** option.





You can add incoming callers by answering the call and pressing **Options**, followed by **Join**. Repeat as required.

Having a Private Conversation With One Participant

1. Press the **Options** soft key and choose the **Select one** option.
The list of call participants appears.

2. Highlight the required person, by pressing the  or  key, followed by the **Select** soft key or the  key.
3. Select **Private**.
Now you can talk privately with that person. The other participants can continue to converse with each other.
4. To return to the multiparty call, press the **Options** soft key and select **Join**.
All the multiparty call participants can now hear each other.

Dropping One Participant





1. Press the **Options** soft key and choose the **Select one** option.
The list of call participants appears.
2. Highlight the required person, by pressing the  or  key, followed by the **Select** soft key or the  key.
3. Select **Remove**.
The call is ended with that participant, but you can continue to talk with the other participants.
4. End the multiparty call by closing the phone or pressing the /Ⓚ key.

Using the Menus







The phone offers a range of functions that allow you to tailor the phone to your needs. These functions are arranged in menus and sub-menus.

The menus and sub-menus can be accessed by scrolling or by using the shortcuts.

Accessing Menu Functions by Scrolling

1. In idle mode, press the **Menu** soft key to access the menu facility. Scroll with the  or  keys to reach the required main menu, **Phone Settings** for example. Press the **Select** soft key or the  key to enter the menu.
2. If the menu contains any sub-menus, **Language** for example, you can access them by scrolling with the  or  keys and pressing the **Select** soft key.

If the menu that you have selected contains further options, repeat the same procedure.

- | | |
|---|--|
| 3. To... | Then press the... |
| Scroll through the menus |  or  keys or the  and  keys on the left side of the phone. |
| Confirm the chosen setting | Select soft key. |
| Return to the previous menu level |  soft key. |
| Exit the menu without changing the settings |  /⓪ key. |

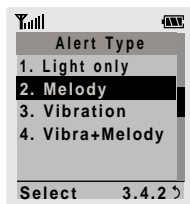

Accessing Menu Functions by Using Shortcuts

The menu items (menu, sub-menus and options) are numbered and can be accessed quickly by using their shortcut number. The shortcut number is shown in the bottom-right next to the ↵ soft key on the display.



1. In idle mode, press the **Menu** soft key to access the menu facility.
2. Within three seconds, key in the first digit of the shortcut number. Repeat this for each digit of the shortcut number.

Example: setting the **Alert Type** function

Press the **Menu** soft key, and key in , , .

Menu to enter the menu, **3** for **Sound Settings**, **4** for **Alert Type** and **2** for **Melody**.

Note: The numbers assigned to each menu option are indicated in the list on page 57. They may not match the menu number on the phone. It depends on the services supported by the SIM card.

Menu Map

The following illustration shows the menu structure available and indicates the:

- Number assigned to each option
- Page on which you can find a description of each feature

Note: If you use a SIM AT card that provides additional services, the **SIM AT** menu (10) is displayed first when you press the **Menu** soft key to enter the menu facility. For further details, refer to your SIM card documentation.

1. Call Records (see page 61)

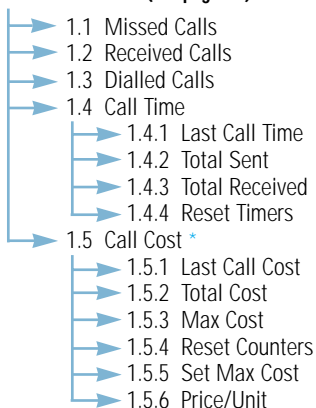

2. Messages (see page 64)

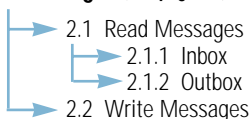

* Shown only if supported by your SIM card.

2. Messages (continued)

- 2.3 Preset Message List
- 2.4 Setup
 - 2.4.1 Setting 1
 - 2.4.2 Setting 2 *
 - 2.4.3 Setting 3 *
 - 2.4.4 Common Setting
- 2.5 Broadcast
 - 2.5.1 Read
 - 2.5.1.1 Archive
 - 2.5.1.2 Volatile
 - 2.5.2 Receive
 - 2.5.3 Channel List
 - 2.5.3.1 Select
 - 2.5.3.2 Add Channel
 - 2.5.3.3 Delete
 - 2.5.3.4 Edit
 - 2.5.4 Language
- 2.6 Voice Mail
 - 2.6.1 Connect to Voice Server
 - 2.6.2 Voice Server

3. Sound Settings (see page 71)

- 3.1 Ring Tone
- 3.2 Melody Composer
- 3.3 Ring Volume
- 3.4 Alert Type
- 3.5 Keypad Tone
- 3.6 Message Tone
 - 3.6.1 SMS Tone
 - 3.6.2 CB Tone
- 3.7 Error Tone
- 3.8 Minute Minder
- 3.9 Connect Tone

* Shown only if supported by your SIM card.

4. Phone Settings (see page 77)

- 4.1 Greeting Message
- 4.2 Own Number
- 4.3 Language
- 4.4 Light
- 4.5 Auto Redial
- 4.6 Active Flip
- 4.7 Anykey Answer
- 4.8 Contrast
- 4.9 Reset Settings

5. Organiser (see page 81)

- 5.1 Calendar
- 5.2 To Do List
- 5.3 Time & Date
 - 5.3.1 Set Time
 - 5.3.2 Set Date
 - 5.3.3 World Time
 - 5.3.4 Format
- 5.4 Alarm
 - 5.4.1 Once Alarm
 - 5.4.2 Daily Alarm
 - 5.4.3 Weekly Alarm
 - 5.4.4 Remove Alarm
 - 5.4.5 Autopower
- 5.5 Calculator
- 5.6 ShortCut
 - 5.6.1 Key up
 - 5.6.2 Key down
 - 5.6.3 Key right
 - 5.6.4 Key left
 - 5.6.5 C long press

6. Security (see page 91)

- 6.1 PIN Check
- 6.2 Change PIN
- 6.3 Phone Lock
- 6.4 Change Password
- 6.5 SIM Lock
- 6.6 FDN Mode *
- 6.7 Change PIN2 *

7. Network Services (see page 95)

- 7.1 Call Diverting
 - 7.1.1 Divert Always
 - 7.1.2 Busy
 - 7.1.3 No Reply
 - 7.1.4 Unreachable
 - 7.1.5 Cancel All
- 7.2 Call Barring
 - 7.2.1 All Outgoing
 - 7.2.2 International
 - 7.2.3 International Except to Home
 - 7.2.4 All Incoming
 - 7.2.5 Incoming While Abroad
 - 7.2.6 Cancel All
 - 7.2.7 Change Barring Password
- 7.3 Call Waiting
 - 7.3.1 Voice Calls
 - 7.3.2 Cancel All
- 7.4 Network Selection
 - 7.4.1 Automatic
 - 7.4.2 Manual
- 7.5 Caller ID
 - 7.5.1 Default
 - 7.5.2 Hide Number
 - 7.5.3 Send Number
- 7.6 Closed User Group
 - 7.6.1 Index List
 - 7.6.2 Outside Access
 - 7.6.3 Default Group
 - 7.6.4 Deactivate *

8. Games (see page 103)

9. WAP Browser

The WAP Browser option allows you to access the Internet. For further details on the WAP Browser, refer to the WAP Browser guide supplied with your phone.

* Shown only if the Closed User Group feature is activated.

Call Records

Via this menu, you can view the phone calls:

- Missed
- Received
- Dialed

The number and name (if available) are displayed, together with the date and time at which the call was made or received.

Note: Your phone can keep up to ten numbers in each list.

Missed Calls

Menu 1.1

This option lets you view the last 10 unanswered calls.

You can also:

- Edit the number if available and dial it or save it in the phonebook
- Delete the call from the list

Received Calls

Menu 1.2

This option lets you view the last 10 phone calls answered. You can also:

- Edit the number if available and dial it or save it in the phonebook
- Delete the call from the list

Dialled Calls

Menu 1.3

This option lets you view the last 10 numbers dialled.

You can also:

- Delete the number
- Edit the number and save it in the phonebook
- Redial the number

Call Time

Menu 1.4

This option lets you view the timers for calls made and received. The following timers are available.

Last Call Time: length of the last call.

Total Sent: total length of all calls made since the timer was last reset.

Total Received: total length of all calls received since the timer was last reset.

Reset Timers: option used to reset the call timers; you must first enter the phone password (see page 22) and then press the **OK** soft key.

Note: The actual time invoiced for calls by your service provider may vary, depending on network features, rounding-off for billing purposes and so forth.

Call Cost ^{*}

Menu 1.5

This network feature lets you view the cost of calls. The following options are available.

Last Call Cost: cost of the last call made.

Total Cost: total cost of all calls made since the cost counter was last reset. If the total cost exceeds the maximum cost set via the **Set Max Cost** option, you can no longer make any calls until you reset the counter.

Max Cost: maximum cost set via the **Set Max Cost** option (see below).

Reset Counters: option used to reset the cost counter; you must first enter your PIN2 (see page 24) and then press the **OK** soft key.

Set Max Cost: option used to enter the maximum cost that you authorise for your calls.

Price/Unit: option used to set the cost of one unit; this price per unit is applied when calculating the cost of your calls.

^{*} Shown only if supported by your SIM card.

Messages

The SMS (Short Message Service) function is a network service and may not be supported by your network. Messages can be sent by text, Email and paging messaging systems, provided that these services are supported by your network. To send text messages by phone, you must obtain the number of the SMS centre from your service provider.

When the  icon appears, you have received new text messages. If the message memory is full, an error message is displayed and you cannot receive any new messages. Use the **Delete** option in the **Read Messages** menu (2.1) to delete obsolete messages.

Read Messages

Menu 2.1

Two message boxes are available:

Inbox: used to store the messages that you have received

Outbox: used to store the messages that you have already sent or will send

Select the required box. The list of messages in the box is displayed.

To view a message, highlight it in the list using the  and  key and press the **View** soft key. The screen shows the:

- Sender's phone number (if sent with the message) or name if it is available in your phonebook (inbox only)
- Date and time at which the message was received (inbox only)
- Message text

To scroll through the message, press the  and  keys.

You can choose the following options, by pressing the **Options** soft key.

Delete: allows you to delete obsolete messages.

Text Reply: allows you to reply by sending a text message. You can also change the SMS centre number (if required).

Call Back: allows you to call the sender back.

Cut Number: allows you to extract a number from the message text, so that you can call the number or save it in the phonebook.

Send: allows you to send a message that you have received or saved. You can:

- Send the message
- Save and send the message
- Save but not send the message

Edit Message: allows you to edit a message.

Note: The options available vary, depending on the message status (new/old, not sent or sent for example).

Write Messages

Menu 2.2

Via this menu, you can write text messages of up to 160 alphanumeric characters.

Note: For further details on how to enter the characters in your message, refer to page 43.

After you complete the message, you can select the following options.

Send Only: enter the destination and select a setting group in which you set up default information on the SMS feature via the **Setup** menu (see the following page).

Save and Send: allows you to save a copy of the message and then send the message to the required destination. You are also required to select a setting group. You can read the message in your outbox using the **Read Messages** option.

Save Only: allows you to save the message so that it can be sent later. You can read the message in your outbox using the **Read Messages** option.

Preset Message List

Menu 2.3

Using this menu, you can preset up to five messages that you use most frequently. This menu shows the preset message list. Scroll through the list using the **←** and **→** keys. When the required message number appears, press the **Options** soft key.

Edit: allows you to write a new message or edit the selected preset message.

Note: For further information on how to enter the characters in your message, refer to page 43.

Send Message: allows you to recall the selected message. Once you have completed the message, you can send, save and send, or simply save it.

Delete: allows you to delete the selected message. You are asked to confirm the deletion by pressing the **Yes** soft key.

Setup

Menu 2.4

Via this menu, you can set up default SMS information. A setting group is a collection of settings required to send messages. The number of setting groups available depends on the capacity of your SIM card.

Setting x (where **x** is the setting group number): each group has its own sub-menu.

Service Centre: allows you to store or change the number of your SMS centre required when sending messages. You must obtain this number from your service provider.

Default Type: allows you to set the default message type (Text, Email and Paging). The network can convert the messages into the selected format.

Default Validity: allows you to set the length of time for which your text messages will be stored at the message centre while attempts are made to deliver them to you.

Setting Name: allows you to give a name to the setting group currently being defined.

Common Setting: three options are available.

Reply Path: allows the recipient of your SMS message to send you a reply message via your message centre, if the service is provided by the network.

Delivery Reports: allows you to activate or deactivate the report function. When this function is activated, the network informs you whether your message has been delivered or not.

Bearer Selection: allows you to choose between GSM and GPRS.

Broadcast

Menu 2.5

This network service allows you to receive text messages on various topics, such as the weather or traffic. Messages are displayed immediately they are received, provided that:

- The phone is in the idle mode
- The **Receive** option is set to **Enable**
- The message channel is currently active in the channel list

The following options are available.

Read: lets you view the messages. **Volatile** displays the messages from the network, but loses its contents as soon as the phone is switched off. Scroll through the message using the **←** and **→** keys. While reading a message, press the **Save** soft key to store the message into the **Archive** for later retrieval.

Receive: allows you to enable or disable the reception of broadcast messages.

Channel List: allows you to indicate the channels from which you wish to receive broadcast messages. Several options are available.

Select: used to enable or disable channels in the list by marking or unmarking them respectively (a check mark is displayed in front of each channel selected).

Add Channel: used to declare the ID and title for a new channel.

Delete: used to remove a channel from the list.

Edit: used to change the ID and title of an existing channel.

Language: allows you to select your preferred language to be used when displaying cell broadcast messages.

Please contact your service provider for more information.

Voice Mail

Menu 2.6

This menu provides you with a quick way of accessing your voice mailbox (if provided by your network).

To quickly connect to the voice server, press and hold down the **1** key.

Note: Voice Mail is a network feature. Please contact your service provider for more information.

Connect to Voice Server: before using this feature, you must enter the voice server number obtained from your service provider (see menu option **2.6.2**). You can then select this option and simply press the **OK** soft key to listen to your messages.

Voice Server: allows you to change the voice mail server number.

To...	Then press the...
Enter the server number	Corresponding numeric keys.
Correct a digit	C key.
Move the cursor to the left/right without clearing the digit	(or) key.

Sound Settings

You can use the Sound Settings feature to customise various settings, such as the:

- Ringing tone or melody, volume and type
- Sounds made when you press a key, make an error or receive a message

Ring Tone

Menu 3.1

This option allows you to select the required ringing tone. You can choose between 18 different tones. Each time you select a tone, it is played for a few seconds. Two additional options correspond to the melodies that you can compose, using the **Melody Composer** menu option (**3.2**).

Melody Composer

Menu 3.2

This option allows you to compose your own melody to be used as the ring tone.

Three octaves are available. A maximum of 100 notes can be entered. You can adjust the length of the notes and add rests, as required.

Composing a Melody

You can compose two melodies.

1. When you access the menu, the names of any melodies created are displayed. Otherwise, **Melody 1** and **Melody 2** appear. Select the melody that you wish to create or edit.

- Press the **Edit** soft key and compose your melody using the following keys.

To...

Enter C, the first note in the musical scale (do)

 key.

Enter D (re)

 key.

Enter E (mi)

 key.

Enter F (fa)

 key.

Enter G (soh)

 key.

Enter A (la)

 key.

Enter B (si)

 key.

Move a note up or down one octave

 key.

Insert the same note again

Next soft key.

Enter a rest

) key (press the key until the rest is of the required length).

Delete a note

C key.

Move a note a semitone up or down

— or — key (for example, the note A changes to A#, B, C, C#, and so on in the scale each time you press the — key).

Change the length of a note

(key (the length will be changed each time you press the key).

Listen to your melody

Listen soft key.

Modify your melody

Modify soft key.

Then press the...

- When you are satisfied with your melody, press the **Save** soft key.

- Enter a title for the melody.

Note: For further details on how to enter characters, refer to page 43.

You are asked if the melody is to become the ring tone.

- To use the melody as the ring tone, press the **Yes** soft key.

The melody is saved and is played each time your phone rings. You can also select the melodies composed via the **Ring Tone** menu option (3.1).

Otherwise, press the **No** soft key. The melody is saved only.

Deleting a Melody

- Select the melody that you wish to delete.
- Press the **Delete** soft key.
- You are asked to confirm that you wish to delete the melody by pressing the **Yes** soft key.

Ring Volume*Menu 3.3*

This option allows you to adjust the ringing volume to one of five levels.

Use the — and — keys or the ▲ and ▼ keys on the left side of the phone. The greater the number of bars, the greater the volume.

Alert Type

Menu 3.4

This option allows you to indicate how you are to be informed of any incoming calls. The following options are available.

Light only: only the backlight is switched on; the phone neither rings nor vibrates.

Melody: the phone rings using the ringing tone selected via the **Ring Tone** menu option (3.1).

Vibration: the phone vibrates but does not ring.

Note: In idle mode, you can set the phone to vibrate only (silent mode) or to start ringing again, simply by pressing one of the shortcut keys (for further details, see page 90).

Vibra+Melody: the phone first vibrates three times and then starts ringing.

Keypad Tone

Menu 3.5

This option allows you to select the tone that the keypad generates when you press a key. The following options are available.

OFF: the keys do not make any sound.

Tone: each key, when pressed, makes a different sound.

Beep: each key, when pressed, makes the same sound.

Message Tone

Menu 3.6

This option allows you to select how the phone informs you that a new message has been received.

SMS Tone

This option allows you to select how the phone informs you that a new SMS message has been received.

The following options are available.

Light Only: the service light at the top of the phone flashes.

Single Beep: the phone beeps once.

SMS Tone1~10: the phone uses an SMS tone. You are provided with ten SMS tones.

CB Tone

This option allows you to select how the phone informs you that a new cell broadcast (CB) message has been received.

OFF: the phone does not use the CB tone.

CB Tone1~3: the phone uses a CB tone. You are provided with three CB tones.

Error Tone

Menu 3.7

This option allows you to select how the phone informs you that you have made a mistake.

The following options are available.

OFF: the phone does not beep.

ON: the phone beeps to indicate an invalid entry.

Minute Minder

Menu 3.8

This option allows you to specify whether the phone must beep every minute during an outgoing call to keep you informed of the length of your call.

The following options are available.

OFF: the phone does not beep.

ON: the phone beeps every minute.

Connect Tone

Menu 3.9

You can set your phone to beep when the person you are calling answers the phone.

The following options are available.

OFF: the phone does not beep.

ON: the phone beeps when your call is accepted.

Phone Settings

Many different features of your phone can be customised to suit your preferences. All of these features are accessed via the **Phone Settings** menu.

Greeting Message

Menu 4.1

This option allows you to set a greeting message to be displayed briefly when the phone is switched on. The current message is displayed.

To...

Clear the existing message

Enter a new message

Change the text input mode

Then press the...

C key and hold it down until the message is cleared.

Appropriate alphanumeric keys.

↕ soft key.

For further details on how to enter characters, refer to page 43.

Own Number

Menu 4.2

This feature allows you to:

- Assign a name to each of your own phone numbers registered on your SIM card
- Edit the names and numbers

This function is a memory aid, which you can use to check your own phone numbers if you need to do so. Any changes made here do not in any way affect the actual subscriber numbers on your SIM card.

Language

Menu 4.3

You can select a display language. When the language option is set to **Automatic**, the language is automatically selected according to the language of the SIM card used.

Light

Menu 4.4

Back Light

You can select whether or not the phone uses the backlight. A marginal increase in standby/talk time can be achieved by turning the backlight off.

The following options are available.

OFF: the backlight is not used.

Short: the backlight comes on when you press a key or receive a call and switches off 10 seconds after the last key is pressed.

Long: the backlight comes on when you press a key or receive a call and switches off 20 seconds after the last key is pressed.

Service Light

This option allows you to select whether or not the service light on the top of the phone is used.

The following options are available.

OFF: the service light is not used.

ON: the service light flashes when the phone is ready for use.

Auto Redial

Menu 4.5

With the Auto Redial function, the phone makes up to ten attempts to redial a phone number after an unsuccessful call.

Note: The interval between two call attempts varies.

The following options are available.

OFF: the number is not redialled.

ON: the number is redialled automatically.

Active Flip

Menu 4.6

This option allows you to answer a call simply by opening the flip.



The following options are available.

Disable: to answer a call, you must open the flip and press any key except **C**, /[Ⓜ] and the **Reject** soft key.

Enable: to answer a call, you simply open the flip.

Anykey Answer

Menu 4.7

Depending on the setting of the **Anykey Answer** option, you can answer an incoming call by pressing any key except the /Ⓜ key and the **Reject** soft key. To reject the call, press /Ⓜ or the **Reject** soft key.



The following options are available.

OFF: you can only press the  key or **Accept** soft key.

ON: you can press any key except /Ⓜ and the **Reject** soft key.

Contrast

Menu 4.8

This option allows you to adjust the contrast of the main LCD screen by pressing the  and  keys.

Note: This setting does not affect to the external LCD.

Reset Settings

Menu 4.9

You can easily reset your phone to its default configuration. To do so, proceed as follows.

1. Select the **Reset Settings** menu option.
2. Enter the 8-digit phone password.

Note: The password is preset to 00000000. To change this password, refer to page 93.

Organiser

The Organiser feature enables you to:

- View the calendar and organise your schedule
- Define a list of things to do
- Set the current date and time
- Set the alarm so that the phone rings at a specific time (to remind you of an appointment for example)
- Assign functions to the navigation keys so that they can be used as shortcuts giving direct access to your favourite menus

Calendar



Menu 5.1

With the Calendar feature, you can:

- Consult the calendar
- Write memos to keep a track of your schedule and trigger an alarm if necessary

Consulting the Calendar

When you select the **Calendar** menu option (5.1), the calendar is displayed. The following options are available when you press the **Options** soft key.

Search all: displays all memos set, regardless of the day and starting with the oldest. To scroll through the memos, press the  and  keys.

Delete all: allows you to delete all memos. You are asked to confirm your action.

Go to date: allows you to jump to a specific date.

Exit: exits the **Calendar** feature and returns to the idle mode.

Writing a Memo

To write or edit a memo on a specific date, proceed as follows.

1. Select the required date in the calendar, using the navigation keys.
Note: To skip to the previous or next month, press the ▲ and ▼ keys on the left side of the phone.
2. Press the **Select** soft key.
An empty memo screen is displayed to allow you to enter your memo.
3. Enter your memo and then press the **OK** soft key.
Note: For further details on how to enter characters, refer to page 43.
You are asked if you wish to set the alarm.
4. If you want the alarm to ring on the chosen day, press the **Yes** soft key.
Otherwise, press the **No** soft key.
5. If you pressed **Yes**, set the time for the alarm and press **OK**.
A check mark is displayed in front of the date in the calendar to indicate that a memo exists.

Editing a Memo

If you select a day for which a memo already exists, you can press the **Edit** soft key to edit the memo displayed.

Note: For further details on how to enter characters, refer to page 43.

Once you have finished editing the memo, press the **OK** soft key. The following options are then available when you press the **Options** soft key.

Alarm: allows you to set the alarm to ring on the chosen day.

Erase: allows you to delete the memo.

Copy to: allows you to copy the memo to another date and/or time.

Move to: allows you to change the date and/or time of the memo.

To Do List

Menu 5.2

This feature allows you to:

- Draw up a list of tasks to be done
- Assign a priority and deadline to each task
- Sort the tasks by priority and status mark (□ for tasks to be done, ✓ for completed tasks)

Creating the To Do List

To create the To Do List, proceed as follows.

1. Press the **New** soft key.
2. Enter the first task.
Note: You can enter up to 48 characters. For further details on how to enter characters, see page 43.
3. Press the **OK** soft key.

4. Select high or low priority using the **↑** or **↓** key and the **Select** soft key.
5. Enter your deadline.
6. Press the **OK** soft key.

Editing the To Do List

If tasks are already defined in the To Do List when you select the **To Do List** menu option (5.2), the current contents are displayed with the associated status mark and priority. The following options are available.

To...	Then...
View the details for a specific task	<ul style="list-style-type: none"> • Highlight the task. • Press the View soft key. • Press the * key to mark the task as completed as of the current date and time.
Change the status of a specific task (□ or ✓)	<ul style="list-style-type: none"> • Highlight the task. • Press the * key. <p>or</p> <ul style="list-style-type: none"> • Highlight the task. • Press the Options soft key. • Select the Mark option. • Select the appropriate status.
Create a new task	<ul style="list-style-type: none"> • Press the Options soft key. • Select the New option. • Enter the text, priority and deadline for the task.

To...

Edit an existing task

Sort the existing tasks by priority or status

Copy a task

Delete a task

Delete all tasks

Exit the To Do list

Then...

- Highlight the task.
 - Press the **Options** soft key.
 - Select the **Edit** option.
 - Change the text, priority and deadline for the task.
-
- Press the **Options** soft key.
 - Select the **Sort** option.
 - Select the sort criterion (high, low, done, undo).
-
- Highlight the task.
 - Press the **Options** soft key.
 - Select the **Copy** option.
 - Change the text, priority and deadline for the task as required.
-
- Highlight the task.
 - Press the **Options** soft key.
 - Select the **Delete** option.
-
- Press the **Options** soft key.
 - Select the **Delete all** option.
 - Confirm the deletion by pressing **OK**.
-
- Press the **Options** soft key.
 - Select the **Exit** option.

Time & Date

Menu 5.3

This option allows you to change the current time and date displayed. You can also check the current time for Greenwich Mean Time (GMT) and 21 major cities around the world.

The following options are available.

Set Time: allows you to enter the current time. You can choose the time format via the **Format** menu option (5.3.4).

Note: Before setting the time, you must specify your time zone, via the **World Time** menu option (5.3.3).

Set Date: allows you to enter the day, month and year. You can change the date format via the **Format** menu option (5.3.4).

World Time: allows you to check the current time for Greenwich Mean Time (GMT) and 21 major cities around the world, using the **(** and **)** keys.

The screen shows the:

- City name
- Current date and time
- Time difference between the selected city and your city if you have set the local time (see the following page for further details) or GMT (by default)

To select the time zone in which you are located, proceed as follows.

1. Select the city corresponding to your time zone by pressing the **—** and **—** keys one or more times. The local date and time are displayed.
2. Press the **Set** soft key.

Format: allows you to change the time and date formats.

Time format: 24 Hours
12 Hours

Date format: YYYY/MM/DD (year/month/day)
DD/MM/YYYY (day/month/year)
MM/DD/YYYY (month/day/year)

Alarm

Menu 5.4

This feature allows you to:

- Set the alarm to ring at a specific time
- Set the phone to ring the alarm at the specified time even while the phone is switched off (**Autopower** menu option set to **Enable**)

In the **Alarm** menu, the following options are available.

Once Alarm: the alarm rings only once and is then deactivated.

Daily Alarm: the alarm rings every day at the same time.

Weekly Alarm: the alarm rings every week on the same day and at the same time.

To set the alarm, proceed as follows.

1. Choose the alarm frequency option.
2. Enter the required time and day of the week (if applicable).

To stop the alarm when it rings, open the flip and press the **Exit** soft key.

Remove Alarm: deactivates the alarm.

Autopower: if this option is set to **Enable**, the alarm will ring at the specified time, even when the phone is switched off.

To...	Then...
Switch the phone on	Hold down the  key.
Switch the phone off again	Press the Exit soft key or any other key.

If the menu option is set to **Disable** and the phone is switched off at the specified time, the alarm will not ring.

Calculator

Menu 5.5

Using this feature, you can use the phone as a calculator. The calculator provides the basic arithmetic functions: addition, subtraction, multiplication and division.

Using the Calculator

1. Enter the first number using the numeric keys.
2. Press the right soft key until the required arithmetic symbol appears: + (add), - (subtract), x (multiply), / (divide).
3. Enter the second number.
4. Repeat Steps 1 to 3 as many times as required.

Notes:

- To erase any mistakes and clear the display, press the **C** key.
 - To include a decimal point or a bracket, press the left soft key until the required symbol is displayed.
5. To calculate the result, press the  key.

Shortcut

Menu 5.6

The four navigation keys and the **C** key can also be used as shortcut keys. When held down in idle mode, they allow you to access specific menu options directly. Using the **Shortcut** menu option (5.6), the following menu options can be assigned to the shortcut keys:

- **None**
- **Silent mode** (Vibration setting in menu option 3.4)
- **Calendar** (menu option 5.1)
- **Calculator** (menu option 5.5)
- **Messages** (menu option 2)
- **Sound Settings** (menu option 3)
- **Games** (menu option 8)
- **To Do List** (menu option 5.2)
- **Voice Mail** (menu option 2.6)
- **Broadcast** (menu option 2.5)

1. Select the key to be used as a shortcut key:
 - Key up (⬆)
 - Key down (⬇)
 - Key right (⬆)
 - Key left (⬅)
 - **C** held down (long press)
2. Select the menu option to be assigned to the key.

Note: To deactivate a shortcut key, select the **None** option.

Security

The Security feature enables you to restrict the use of your phone to:

- The people of your choice
- The types of calls of your choice

Various codes and passwords are used to protect the features of your phone. They are described in the following sections (see also pages 22-25).

PIN Check

Menu 6.1

When the PIN Check feature is enabled, you must enter your PIN each time you switch the phone on. Consequently, any person who does not have your PIN cannot use your phone without your approval.

Note: Before disabling the PIN Check feature, you must enter your PIN.

To change your PIN, refer to menu option 6.2.

The following options are available.

Disable: the phone connects directly to the network when you switch it on.

Enable: you must enter the PIN each time the phone is switched on.

Change PIN

Menu 6.2

This feature allows you to change your current PIN to a new one, provided that the PIN Check feature is enabled. You must enter the current PIN before you can specify a new one.

Once you have entered a new PIN, you are asked to confirm it by entering it again.

Phone Lock

Menu 6.3

When the Phone Lock feature is enabled, the phone is locked and you must enter the 8-digit phone password each time the phone is switched on.

The password is factory set to 00000000. To change the phone password, refer to menu option **6.4** on the following page.

Once the correct password has been entered, you can use the phone until you switch it off.

The following options are available.

Disable: you are not asked to enter the phone password when you switch the phone on.

Enable: you are required to enter the phone password when you switch the phone on.

Change Password

Menu 6.4

The Change Password feature allows you to change your current phone password to a new one. You must enter the current password before you can specify a new one.

The password is factory set to 00000000. Once you have entered a new password, you are asked to confirm it by entering it again.

SIM Lock

Menu 6.5

When the SIM Lock feature is enabled, your phone only works with the current SIM. You must enter the SIM lock code.

Once you have entered the lock code, you are asked to confirm it by entering it again.

To unlock the SIM, you must enter the SIM lock code.

FDN Mode

Menu 6.6

The FDN (Fixed Dial Number) mode, if supported by your SIM card, allows you to restrict your outgoing calls to a limited set of phone numbers.

The following options are available.

Disable: you can phone any number.

Enable: you can only call phone numbers stored in the phonebook. You must enter your PIN2.

Note: Not all SIM cards have a PIN2. If your SIM card does not, this menu option is not displayed.

To change your PIN2, refer to menu option **6.7** below.

Change PIN2

Menu 6.7

The Change PIN2 feature allows you to change your current PIN2 to a new one. You must enter the current PIN2 before you can specify a new one.

Once you have entered a new PIN2, you are asked to confirm it by entering it again.

Note: Not all SIM cards have a PIN2. If your SIM card does not, this menu option is not displayed.

Network Services

These menu functions are network services.

Please contact your service provider to check their availability and subscribe to them, if you so wish.

Call Diverting

Menu 7.1

This network service enables incoming calls to be rerouted to the number that you specify.

Example: You may wish to divert your business calls to a colleague while you are on holiday.

Call diverting can be set up in the following ways.

Divert Always: all calls are diverted.

Busy: calls are diverted if you are already making another call.

No Reply: calls are diverted if you do not answer the phone.

Unreachable: calls are diverted if you are not in an area covered by your service provider.

Cancel All: all call diverting options are cancelled.

You can specify individual diverting options for each of the following call types:

- Voice calls only
- Data calls only

Example: You can divert voice calls to your colleague if you are already using the phone.

To set your call diverting options, proceed as follows.

1. Select the type of call diverting required by pressing the **←** or **→** key until the appropriate option is highlighted, and then press **Select**.
2. Select the type of calls to be diverted by pressing the **←** or **→** key until the appropriate option is highlighted and then press **Select**.

The current status is displayed. If the option has already been set, the number to which the calls are diverted is displayed.

- | 3. To... | Then... |
|---------------------------|--|
| Activate call diverting | <ul style="list-style-type: none"> • Press the Activate soft key. • Go to step 4. |
| Change the call number | <ul style="list-style-type: none"> • Press the Change soft key. • Go to step 4. |
| Deactivate call diverting | Press the Remove soft key. |
4. Enter the number to which the calls are to be diverted and press **OK**.
To enter the international code, press the **0** key until the + sign is displayed.

The phone sends your settings to the network and the network's acknowledgement is displayed.

You can deactivate all call diverting settings by selecting the **Cancel All** option.

Call Barring

Menu 7.2

The call barring network service allows you to restrict your calls.

Call barring can be set up in the following ways.

All Outgoing: calls cannot be made.

International: international calls cannot be made.

International Except to Home: when abroad, calls can be made only to numbers within the current country and to your home country, that is the country where your home network provider is located.

All Incoming: calls cannot be received.

Incoming While Abroad: calls cannot be received when you are using your phone outside your home service area.



Cancel All: all call barring settings are deactivated; calls can be made and received normally.

You can specify individual barring options for each of the following call types:

- Voice calls only
- Data calls only

To set your call barring options, proceed as follows.

1. Select the type of call barring required by pressing the **←** or **→** key until the appropriate option is highlighted and then press the **Select** soft key.

2. Select the type of calls to be barred by pressing the  or  key until the appropriate option is highlighted and then press **Select**.
3. Press the **Activate** soft key to confirm your settings.
4. Enter your call barring password supplied by your service provider.

The phone sends your settings to the network and the network's acknowledgement is displayed.

To deactivate specific call barring settings, proceed as follows.

1. Select the call barring option to be deactivated.
2. Select the type of call to which this option applies.
3. Press the **Deactivate** soft key.
4. Enter your call barring password supplied by your service provider.

The phone sends your settings to the network and the network's acknowledgement is displayed.

You can also deactivate all call barring settings by selecting the **Cancel All** option.

Change Barring Password: you can set and change the call barring password obtained from your service provider using this option. You must enter the current password before you can specify a new one.

Once you have entered a new password, you are asked to confirm it by entering it again.

Call Waiting



Menu 7.3

This network service enables you to be informed when someone is trying to reach you during another call.

You can specify individual call waiting options for each of the following call types:

- Voice calls only
- Data calls only

To set your call waiting options, proceed as follows.

1. Select the type of calls to which the call waiting option is to be applied by pressing the  or  key until the appropriate option is highlighted. Then press **Select**.

The screen informs you whether call waiting is activated or deactivated.

2. You can activate or deactivate the call waiting feature as necessary using the **Activate** or **Deactivate** soft key respectively.

To return to the previous screen, press the **Exit** soft key.

You can also deactivate all call waiting settings by selecting the **Cancel All** option.

Network Selection

Menu 7.4

The Network Selection feature enables you to indicate whether the network used when roaming (outside your home area) is selected automatically or manually.

Note: You can select a network other than your home network only if it has a valid roaming agreement with your home network.

To indicate whether the network is to be selected automatically or manually when roaming, proceed as follows.

1. When **Network Selection** is displayed, press the **Select** soft key.
2. Press the **←** or **→** key until the appropriate option is highlighted and then press the **OK** soft key.

If you select **Automatic**, you are connected to the first available network when roaming.

If you select **Manual**, the phone scans for the available networks. Go to Step 3.

3. Press the **←** or **→** key until the preferred network is highlighted and then press the **OK** soft key.

You are connected to that network.

Caller ID

Menu 7.5

You can prevent your phone number from being displayed on the phone of the person being called.

Note: Some networks do not allow the user to change this setting.

The following options are available.

Default: the default setting provided by the network is used.

Hide Number: your number is not displayed on the other person's phone.

Send Number: your number is sent each time you make a call.

Closed User Group (CUG)

Menu 7.6

This network service allows incoming and outgoing calls to be restricted to a selected user group. You may be a member of up to ten user groups.

For details on how to create, activate and use a closed user group, contact your service provider.

Example: A company lends SIM cards to its employees and wants to restrict outgoing calls to members of the same team.

Activating a Closed User Group

If you select the **Closed User Group** menu, you can enter the CUG function. You can now access the following options after pressing the **Select** soft key.

Index List: lets you list, add or delete CUG index

numbers. The list of current CUG indexes appears. Add a new CUG index (as advised by your service provider) or delete a selected group.

To...	Then press the...
Scroll through the existing CUG indexes	← or → key.
Add a new CUG index	Options soft key, select the Add option and enter the index.
Delete a CUG index	Options soft key and select the Delete option.
Activate a CUG index	Options soft key and select the Activate option.

Outside Access: lets you enable or disable calls to numbers other than those nominated for the Closed User Group. This feature depends on the nature of your CUG subscription. Please check with your service provider.

Default Group: you may communicate a default CUG to your service provider. If you have done so, you can enable the **Default Group** option on your phone. When making a call, you will be given the option of using your default CUG, instead of selecting one from the list.

Deactivate: deactivates the CUG function. This menu appears only when the default group is enabled or a CUG index is selected.

Using this feature, you can play seven different games with the phone:

- Casino
- Roulette
- Black Jack
- Sniper
- Snake
- Mole
- Othello

Once you have selected a game, the following options are available.

Play: allows you to start a game.

Level: allows you to select the level of difficulty. Select the required level using the (and) keys and press the **OK** soft key. This option is only available in games with several levels (Sniper, Snake).

Configuration: allows you to configure the phone for the chosen game (backlight and sound settings).

To adjust each setting, highlight the **Backlight** or **Sound** option by pressing the ← and → keys and then toggle between **ON** and **OFF** by pressing the **On/Off** soft key.

Instructions: describes the buttons used by the game. If necessary, press the right soft key to see a more detailed description.

High Score: enables you to view the highest score recorded for the selected game. You can also reset this score by pressing the **Reset** soft key.

If you break the current record for the game, the phone displays the High Score screen.

To stop playing a game, press the **C** or  key

WAP Browser

Your phone is equipped with a WAP Browser to allow you to access and navigate the Wireless Web via your phone.

For more details on the WAP Browser menu, refer to the WAP Browser User's Manual supplied with your phone.

Data Communication

You can send or receive data through your phone connected to the PC via a data cable supplied with the phone.

To use the data communication feature, you must:

- Install the modem driver used to send or receive data on your PC; we recommend a standard 9600 bps ~ 19200 bps modem
- Install the network dial-up software supplied by your service provider or any other equivalent product on your PC
- Connect the phone to the PC using the data cable, and dial the network service number given to you by the service provider

For further details, contact your service provider.

Solving Problems

Before contacting the after-sales service, perform the following simple checks. They may save you the time and expense of an unnecessary service call.

When you switch your phone on, the following messages may appear

Insert SIM Card

- Check that the SIM card is correctly installed.

Phone Locked

Enter Password

- The automatic locking function has been enabled. You must enter the phone's password before you can use the phone.

Enter PIN

- You are using your phone for the first time. You must enter the Personal Identification Number supplied with the SIM card.
- The option requiring that the PIN be entered each time the phone is switched on has been enabled. You must enter your PIN and then disable this option if so required.

Enter PUK

- The PIN code was entered wrongly three times in succession and the phone is now blocked. Enter the PUK supplied by your network operator.

“No service”, “Network failure” or “Not done” is displayed

- The network connection was lost. You may be in a weak reception area (in a tunnel or surrounded by buildings). Move and try again.
- You are trying to access an option for which you have not taken out a subscription with your service provider. Contact the service provider for further details.

You have entered a number but it was not dialled

- Have you pressed the  key?
- Are you accessing the right cellular network?
- You may have set an outgoing call barring option.

Your correspondent cannot reach you

- Is your phone switched on (/Ⓚ pressed for more than one second)?
- Are you accessing the right cellular network?
- You may have set an incoming call barring option.

Your correspondent cannot hear you speaking

- Have you switched off the microphone?
- Are you holding the phone close enough to your mouth? The microphone is located in the bottom centre of the phone.

The phone starts beeping and “**Warning** Low Battery” flashes in the display

- The battery is insufficiently charged. Replace the battery and recharge it.

The audio quality of the call is poor

- Check the signal strength indicator in the display (📶); the number of bars after it indicates the signal strength from strong (📶) to weak (📶).
- Try moving the phone slightly or moving closer to a window if you are in a building.

No number is dialed when you recall a phonebook entry

- Check that the numbers have been stored correctly, by using the Phonebook Search feature.
- Re-store them, if necessary.

If the above guidelines do not enable you to solve the problem, take a note of:

- The model and serial numbers of your phone
- Your warranty details
- A clear description of the problem

Then contact your local dealer or SAMSUNG after-sales service.

Using the Batteries

Your phone is powered by a rechargeable Li-ion battery. The following batteries are also available (ask your SAMSUNG dealer for further details):

- Slim battery
- Standard battery

Precautions When Using Batteries

- Never use any charger or battery that is damaged in any way.
- Use the battery only for its intended purpose.
- If you use the phone near the network's base station, it uses less power; talk and standby times are greatly affected by the signal strength on the cellular network and the parameters set by the network operator.
- Battery charging times depend on the remaining battery charge and the type of battery and charger used. The battery can be charged and discharged hundreds of times, but it will gradually wear out. When the operation time (talk time and standby time) is noticeably shorter than normal, it is time to buy a new battery.
- If left unused, a fully charged battery will discharge itself over time.

- Use only Samsung-approved batteries and recharge your battery only with Samsung-approved chargers. When a charger is not in use, disconnect it from the power source. Do not leave the battery connected to a charger for more than a week, since overcharging may shorten its life.
- Extreme temperatures will affect the charging capacity of your battery: it may require cooling or warming first.
- Do not leave the battery in hot or cold places, such as in a car in summer or winter conditions, as you will reduce the capacity and life-time of the battery. Always try to keep the battery at room temperature. A phone with a hot or cold battery may temporarily not work, even when the battery is fully charged. Li-ion batteries are particularly affected by temperatures below 0 °C (32 °F).
- Do not short-circuit the battery. Accidental short circuiting can occur when a metallic object (coin, clip or pen) causes a direct connection between the + and – terminals of the battery (metal strips on the battery), for example when you carry a spare battery in a pocket or bag. Short-circuiting the terminals may damage the battery or the object causing the short-circuit.
- Dispose of used batteries in accordance with local regulations. Always recycle. Do not dispose of batteries in a fire.

Safety Information

Road Safety

- Remember, road safety always comes first!
- Do not use a hand-held phone while driving a vehicle. Always park the vehicle before having a conversation.
- Make sure that the phone is stored safely and will not fall or be broken in the event of a collision or emergency stop.
- The use of an alert device to operate a vehicle's lights or horn on public roads is not permitted.
- Only qualified personnel should install or service the phone in a vehicle. Faulty installation or service may be dangerous and may invalidate any warranty applicable to the unit.
- Electronic fuel injection, anti-skid braking, electronic cruise control or any other electronic systems may malfunction due to the lack of protection from radio signals. Check regularly that all cellular phone equipment in your vehicle is mounted and operating correctly.

Operating Environment

- Remember to follow any special regulations in force in any area and always switch off your phone whenever it is forbidden to use it, or when it may cause interference or danger (in a hospital for example).

- Operation of any radio-transmitting equipment, including cellular phones, may interfere with inadequately protected medical devices. Consult a doctor or the manufacturer of the medical device if you have any questions. Other electronic equipment may also be subject to interference.
- As with other mobile radio-transmitting equipment, you are advised that for satisfactory operations and personal safety, the equipment should only be used in the normal operating position.
- Always switch off the phone when at a refuelling point (service station). You are reminded of the need to observe restrictions on the use of radio equipment in fuel depots (fuel storage and distribution areas), chemical plants or where blasting operations are in progress.
- Do not store or carry flammable liquids, gases or explosive materials in the same compartment as the phone, its parts or accessories.
- Switch off your cellular phone when in an aircraft. The use of cellular phones in aircraft is illegal and may be dangerous to the operation of the aircraft or disrupt the cellular network. Failure to observe these instructions may lead to the suspension or denial of cellular telephone services to the offender, legal action or both.

Care and Maintenance

Your phone is a product of superior design and craftsmanship and should be treated with care. The suggestions below will help you fulfill the warranty obligations and enjoy this product for many years.

- Keep the phone and all its parts and accessories out of the reach of small children.
- Keep the phone dry. Precipitation, humidity and liquids containing minerals will corrode the electronic circuits.
- Do not use or store the phone in dusty, dirty areas as its components may be damaged.
- Do not store the phone in hot areas. High temperatures can shorten the life of electronic devices, damage batteries and warp or melt certain plastics.
- Do not store the phone in cold areas. When the phone warms up to its normal temperature, moisture can form inside the phone, which may damage the electronic circuits.
- Do not attempt to open the phone's casing. Non-expert handling of the phone may damage it.
- Do not drop or knock the phone. Rough handling may damage the internal circuits.

- Do not use harsh chemicals, cleaning solvents or strong detergents to clean the phone. Wipe it with a soft cloth slightly dampened in mild, soapy water.
- If the phone or any of its accessories are not working properly, take them to your nearest qualified service centre. The personnel there will assist you, and if necessary, arrange for the phone to be repaired.

Emergency Calls

Important! This phone, like any cellular phone, uses radio signals, cellular and landline networks, as well as user-programmed functions that cannot guarantee connection in all conditions. Therefore, you should never rely solely on any cellular phone for essential communications (medical emergencies for example).

Remember, to make or receive any calls, the phone must be switched on and in a service area with adequate cellular signal strength.

Emergency calls may not be possible on all cellular phone networks or when certain network services and/or phone features are in use. Check with local cellular service providers.

Glossary of Terms

To help you understand the main technical terms and abbreviations used in this booklet and take full advantage of the features on your mobile phone, here are a few definitions.

Active Flip

Ability to answer a call simply by opening the phone.

Call Barring

Ability to restrict outgoing and incoming calls.

Call Diverting

Ability to reroute calls to another number.

Call Holding

Ability to put one call on standby while answering or making another call; you can then switch between the two calls, as required.

Call Waiting

Ability to inform users that they have an incoming call when engaged on another call.

DCS

Digital cellular network standard based on the GSM network architecture. With the higher frequency range (1800 MHz for DCS instead of 900 MHz for GSM), more radio channels can be made available, thus allowing the network to support more subscribers and traffic.

Dual Band

Ability to operate with both DCS (1800 MHz) and GSM (900 MHz) networks. The phone automatically uses the network with the strongest signal and even switches networks during a call within the same operator's network.

GPRS (General Packet Radio Service)

New non-voice value-added service that allows information to be sent and received across a mobile telephone network. GPRS promises data rates from 56 up to 114 Kbps and continuous connection to the Internet for mobile phone and computer users. It is based on the Global System for Mobile Communication (GSM) and complements existing services, such as circuit-switched cellular phone connections and the Short Message Service (SMS).

GSM (Global System for Mobile Communication)

International standard for cellular communication, guaranteeing compatibility between the various network operators. GSM covers most European countries and many other parts of the world.

Line Identification Services

Services allowing subscribers to view or block the telephone numbers of callers.

Multiparty Calling

Ability to establish a conference call involving up to five additional parties.

Phone Password

Security code used to unlock the phone when you have selected the option to lock it automatically each time it switches on.

PIN (Personal Identification Number)

Security code that protects the phone against unauthorised use. The PIN is supplied by the service provider with the SIM card. It may be a four to eight-digit number and can be changed, as required.

PUK (PIN Unlocking Key)

Security code used to unlock the phone when an incorrect PIN has been entered three times in succession. The eight-digit number is supplied by the service provider with the SIM card.

Roaming

Use of your phone when you are outside your home area (when travelling for example).

SDN (Service Dialling Numbers)

Telephone numbers supplied by your network provider, giving access to special services, such as voice mail, directory inquiries, customer support and emergency services.



SIM (Subscriber Identification Module)

Card containing a chip with all the information required to operate the phone (network and memory information, as well as the subscriber's personal data). The SIM card fits into a small slot on the back of the phone and is protected by the battery.

SMS (Short Message Service)

Network service sending and receiving messages to and from another subscriber without having to speak to the correspondent. The message created or received (up to 160 characters long) can be displayed, received, edited or sent.

Soft Keys

Two keys ( and ) on the phone, the purpose of which:

- Varies according to the function that you are currently using
- Is indicated on the bottom line of the display just above the corresponding key

Voice Mail

Computerised answering service that automatically answers your calls when you are not available, plays a greeting (optionally in your own voice) and records a message.

Index

A

Access codes • 22
 Accessories • 9
 Active Flip (4.6) • 29; 79
 Alarm (5.4) • 87
 Alert Type (3.4) • 74
 Answering
 a call • 29
 a second call • 52
 Anykey Answer (4.7) • 80
 Auto Redial (4.5) • 79
 Autopower (5.4.5) • 88

B

Backlight • 15; 78
 contrast • 80
 Barring
 calls (7.2) • 97
 password • 25; 98
 Batteries
 charging • 19
 low battery indicator • 20
 precautions • 109
 Broadcast (2.5) • 68
 message tone • 75

C

Calendar (5.1) • 81
 Calculator (5.5) • 89
 Caller
 group • 40
 ID (7.5) • 101
 Calls
 answering • 29
 a second call • 52
 barring (7.2) • 97
 cost (1.5) • 63
 dialled (1.3) • 62
 diverting (7.1) • 95
 emergency • 8; 112
 ending • 27
 holding • 48
 international • 26
 making • 26
 missed • 30; 61
 multiparty • 53

Calls (*continued*)

 received (1.2) • 61
 records (1) • 61
 redialling automatically • 79
 time (1.4) • 62
 via the phonebook • 36
 waiting (7.3) • 48; 99

Card

 installing the SIM • 17

Care • 113

Changing

 call barring password • 98
 password (6.4) • 93
 PIN (6.2) • 92
 PIN2 (6.7) • 94
 text modes • 44

Characters

 changing case • 44
 entering • 43

Charging batteries • 19

Closed User Group (7.6) • 101

Communication

 data • 105

Composer

 Melody (3.2) • 71

Conference calls

 • See Multiparty calls

Connect

 to Voice Mail (2.6.1) • 70
 tone (3.9) • 76

Contrast (4.8) • 80

Copying

 memos • 84
 phonebook numbers • 40

Correcting numbers • 26

Cost of calls • 63

CUG • 101

D

Data communication • 105

Date

 format (5.3.4) • 87
 setting (5.3.2) • 86

Deleting

 memos • 83
 missed calls • 31
 phonebook numbers • 40
 tasks • 85

D *(continued)*Dialled Calls **(1.3)** • 62

Display • 13

contrast • 81

icons • 14

setting the language

(4.3) • 34; 78Diverting calls **(7.1)** • 95**E**

Earpiece

adjusting the volume • 28

Editing

memos • 82

messages • 65

missed calls • 31

phonebook numbers • 40

tasks • 85

To Do List • 84

Emergency calls • 8; 114

Erasing

memos • 83

missed calls • 31

phonebook numbers • 40

tasks • 85

Error Tone **(3.7)** • 76**F**FDN Mode **(6.6)** • 94

Fixed Dial Number mode • 94

Front LCD • 14

Functions

selecting • 32

GGames **(8)** • 103Greeting Message **(4.1)** • 77

Groups

caller • 40

user • 101

H

Holding calls • 48; 99

I

Icons

description • 14

Identifying a caller • 29; 101

K

Key tones

adjusting the volume • 28

muting • 50

selecting • 74

sending • 50

Keypad Tone **(3.5)** • 74

Keys

description • 11; 12

location • 10

shortcut • 90

LLanguage **(4.3)** • 34; 78

Last number redialling • 27

Length of calls • 62; 76

Letters

changing case • 44

entering • 43

Light **(4.4)**

backlight • 15; 78

service • 16; 78

Locking

phone **(6.3)** • 92SIM card **(6.5)** • 93

Low battery indicator • 20

Lower-case characters

entering • 46

M

Maintenance • 113

Melody Composer **(3.2)** • 71

Memory status • 42

Memos

copying • 83

deleting • 83

editing • 82

writing • 82

Menus

by scrolling • 55

by shortcuts • 56

map • 57

using • 55

Message Tone **(3.6)** • 75

Messages

broadcast **(2.5)** • 68greeting **(4.1)** • 77preset **(2.3)** • 66reading **(2.1)** • 64Messages *(continued)*setup **(2.4)** • 67voice mail **(2.6)** • 70writing **(2.2)** • 66

Microphone mute • 49

Minute Minder **(3.8)** • 76Missed calls **(1.1)** • 61

deleting • 31

editing the number • 31

viewing • 30; 61

Multiparty calls

dropping a participant • 54

making • 53

private conversation • 53

Mute

key tones • 50

microphone • 49

N

Names

entering • 43

searching/dialling • 38; 51

storing in the phonebook • 36

Network Selection **(7.4)** • 100Network Services **(7)** • 95

Numbers

copying phonebook • 40

correcting • 26

editing

missed call • 31; 61

phonebook • 40

entering • 47

erasing phonebook • 40

fixed dial • 94

own • 77

redialling • 27

automatically • 79

searching/dialling • 38; 51

storing in the phonebook • 36

O

Options

selecting • 32

Organiser **(5)** • 81Own Number **(4.2)** • 77**P**

Password

barring • 25

changing • 98

phone • 22

changing **(6.4)** • 93

Pasting phonebook numbers • 39

Personal Identification Number

• See PIN

Personal Unblocking Key • 23

Phone

Lock **(6.3)** • 92

password • 22; 93

Settings **(4)** • 77

Phonebook • 36

copying numbers • 40

dialling • 38; 51

editing numbers • 40

erasing numbers • 40

making calls • 38; 51

options • 39

pasting numbers • 39

searching • 38; 51

storing numbers/names • 36

PIN • 23

changing **(6.2)** • 92checking **(6.1)** • 91

PIN2 • 24

changing **(6.7)** • 94Preset Message **(2.3)** • 66

Problem solving • 106

PUK • 23

PUK2 • 24

RRead Messages **(2.1)** • 64Received Calls **(1.2)** • 61

Redialling

automatically **(4.5)** • 79

last number • 27

Reset Settings **(4.9)** • 80

Ring

Tone **(3.1)** • 71

type • 74

Volume **(3.3)** • 73

Roaming • 100







S





- Safety
 - batteries • 109
 - information • 111
 - precautions • 7
- Schedule • 81
- SDN • 42
- Searching for names/numbers • 38; 51
- Security (6) • 91
- Selecting functions/options • 32
- Sending
 - key tones • 50
 - messages • 66
- Service
 - dialling numbers (SDN) • 42
 - light • 16; 78
- Setting
 - alarm (5.4) • 87
 - date (5.3.2) • 86
 - display language • 34; 78
 - time (5.3.1) • 86
- Settings
 - resetting (4.9) • 80
- Setup (2.4) • 67
- ShortCut (5.6) • 90
- SIM card
 - installing • 17
 - locking (6.5) • 93
 - precautions • 17
- SIM Lock (6.5) • 93
- SMS
 - broadcast (2.5) • 68
 - message tone • 75
 - setup (2.4) • 67
 - text message icon • 52; 64
 - using • 52; 64
- Soft keys • 32
- Solving problems • 106
- Sound Settings (3) • 71
- Speed-dialling • 37
- Switching on/off
 - microphone • 49
 - phone • 21



T

- Tasks
 - defining • 83
 - Text
 - changing modes • 44
 - entering • 43
 - Text messages • 64
 - broadcasting (2.5) • 68
 - icon • 52; 64
 - preset (2.3) • 66
 - reading (2.1) • 64
 - setup (2.4) • 67
 - writing (2.2) • 66
 - Time
 - calls (1.4) • 62; 76
 - format (5.3.4) • 87
 - setting (5.3.1) • 86
 - world (5.3.3) • 86
 - To Do List (5.2) • 83
 - Tone
 - connect (3.9) • 76
 - error (3.7) • 76
 - keypad (3.5) • 74
 - melody • 71
 - message (3.6) • 75
 - ring (3.1) • 71
 - Travel adapter • 19
 - T9 mode • 43; 44
- U**
- Upper-case characters
 - entering • 46
 - User groups • 101
- V**
- Vibration • 74
 - Voice mail • 70
 - Voice Server (2.6.2) • 70
 - Volume
 - adjusting • 28
 - selecting the ring (3.3) • 73
- W**
- Waiting
 - call • 48; 99
 - WAP Browser (9) • 105
 - World Time (5.3.3) • 86
 - Write Messages (2.2) • 66
 - Writing memos • 82

Dual Band SGH-Q200 GSM Telephone
Quick Reference Card

Switch On/Off	Press and hold  .
Make a Call	<ol style="list-style-type: none"> ① Key in the number. ② Press the  key.
End a Call	Briefly press the  key.
View Missed Calls Immediately After Missing Them	<ol style="list-style-type: none"> ① Open the phone or press the View soft key. ② Scroll with the  and  keys through the missed calls. ③ To return the call, press the  key.

- Access the Menu Function**
- ① Press the **Menu** soft key.
 - ② Scroll with the  and  keys through the list of menus until you reach the required menu.
 - ③ Press the **Select** soft key.
 - ④ Scroll with the  and  keys through the list of options until the required one is selected.
 - ⑤ Press the **Select** soft key to confirm.

- Each of the two soft keys  and  performs the function indicated by the text above it (bottom line in the display).



Declaration of Conformity (R&TTE)

For the following product :

GPRS GSM TELEPHONE SGH-Q200

(Product name)

SGH-Q200

(Model Number)

Manufactured at :

– Samsung Electronics 94*1 Insa-Dong, Gumi City, Kynug Buk, Korea, 730-350
 – Samsung Electronics Iberia, S.A. Pol. Ind. Riera de Caldes, Via Augusta, n-10
 08184 Palau de Plegamans, Barcelona, Espana

 (factory name, address)

We hereby declare that [all essential radio test suites have been carried out and that] the above named product is in conformity to all the essential requirements of Directive 1999/5/EC.

The conformity assessment procedure referred to in Article 10 and detailed in Annex[II] of Directive 1999/5/EC has been followed with the involvement of the following Notified Body(ies):

BABT, Claremont House, 34 Molesey Road, Walton-on-Thames, KT12 4RQ, UK
 Identification mark: 168

The technical documentation kept at :

Samsung Electronics Euro QA Lab.

which will be made available upon request.
 (Manufacturer)

Samsung Electronics Co.,Ltd.
 Suwon P.O.Box 105
 Kyungki-Do, Korea 440-600
 2001.10.1

(place and date of issue)



JUNGKWAN CHOI / S, Manager

(name and signature of authorized person)







(Representative in the EU)

Samsung Electronics Euro QA Lab.
 Blackbushe Business Park, Saxony Way,
 Yateley, Hampshire, GU46 6GG, UK
 2001.10.1

(place and date of issue)

In-Seop Lee / Manager

(name and signature of authorized person)

Answer a Call	Open the phone or Press the  key.	Store Numbers in the Phonebook ① Key in the number. ② Press the Save soft key ③ Enter the name. ④ Press the OK soft key ⑤ If necessary, change the location. ⑥ Press the OK soft key.
Adjust the Volume	Press the  or  key on the left side of the phone.	
Choose the Alert Type	① Select the Alert Type menu option (3.4). ② Select an option: Light only, Melody, Vibration, Vibra+ Melody. ③ Press the Select soft key to confirm.	Search for a Number in the Phonebook ① Press the Name soft key. ② Enter the start of the name. ③ Press the Search soft key. ④ To scroll through the names, press the  and  keys. ⑤ To make a call, press the  key.