



Prestigio

THE ART OF HI-TECH



MultiPhone PAP3501 DUO

Android Smartphone

User Manual

About this user manual

This user manual is specially designed to detail the device's functions and features.

- Please read this manual before using the device to ensure safe and proper use.
- Descriptions are based on the device's default settings.
- Images and screenshots may differ in appearance from the actual product.
- Prestigio continuously strives to improve its products. Due to software upgrading, some contents in this user manual may be different from your product. Prestigio reserves the rights to revise this user manual or withdraw it at any time without prior notice. Please take your product as standard.
- The Android applications provided on your device have been developed by Android's users or other companies, not by Prestigio and are provided at no charge. Unless otherwise indicated, Prestigio makes no promises nor representations, and takes no responsibilities about their performance, quality, content, or intellectual property rights.

Conventions used in this manual

In this user manual, we use the following symbols to indicate useful and important information:



Caution: safety precaution and important information.



Note: additional information.



Tips: usage tips.

> The order of options or menus you must select to perform a step.

Warranty Information

Prestigio MultiPhone PAP3501 DUO has a two-year warranty.

You may find detailed warranty information at

<http://www.prestigio.com/support/warranty-terms>

Contents

1. Unboxing	1
Inside your package	1
Your phone at a glance	1
Buttons	2
2. Getting started	3
Install the SIM card	3
Insert a memory card	4
Insert the battery	5
Put the rear panel back	5
Power on your phone	6
Home screens	6
List menu	7
3. Basics	8
Finger tips	8
Motion gesture	9
Charge the battery	10
Connect to your PC	11
Lock and unlock the screen	11
Adjust the volume	12
Recently used apps	13
Notifications panel	13
Enter text	14
Use widgets	15
System upgrade	15
Status icons	16
4. Phone	17
Make a call	17
Answer a call	17
Reject a call	17
End a call	17
Contacts	17
Use speed dial	19
Call a phone number in a text message	19
Call a phone number in an e-mail	19
Set up a conference call	20
Make an emergency call	20
5. Messages	21
Send a message	21
Check your message	21
Reply to a message	21
Forward a message	21

Delete your messages	22
Create a conversation shortcut	22
WAP push messages	22
6. Mail	23
Set up an e-mail account	23
Send a mail	23
View your mails	23
Reply to a mail	24
Delete mails	24
Gmail	24
7. Camera	26
Your camera at a glance	26
Take a photo	26
Take a photo of yourself	26
Take a panoramic photo	27
Take continuous shots	27
Record a video	27
Camera scenes	27
Camera and video settings	28
8. Multimedia	29
Gallery	29
Video player	32
Music player	33
FM radio	34
Voice recorder	35
9. Web & network	37
Connect to the Internet	37
VPN	40
Web browse	40
10. Bluetooth	42
Bluetooth	42
11. Apps	44
Play store	44
Manage your apps	44
12. eReader Prestigio	45
Your eReader at a glance	45
Download an e-book	45
Read an e-book	46
eReader settings	46
13. Travel & maps	47
Find a location	47
Get directions	47
Navigation	48

Use Google Maps	48
14. Files and storage	49
Your files	49
Storage	49
15. Utilities	51
Clock	51
Calendar	52
Calculator	52
ToDo list	53
Google search	53
16. Set up your phone	55
Wireless & Networks	55
Device	56
Personal	56
Accounts	57
System	57
17. Specifications	58
18. Specific Absorption Rate Information	59
International standards	59
19. Troubleshooting	60

1. Unboxing



Inside your package



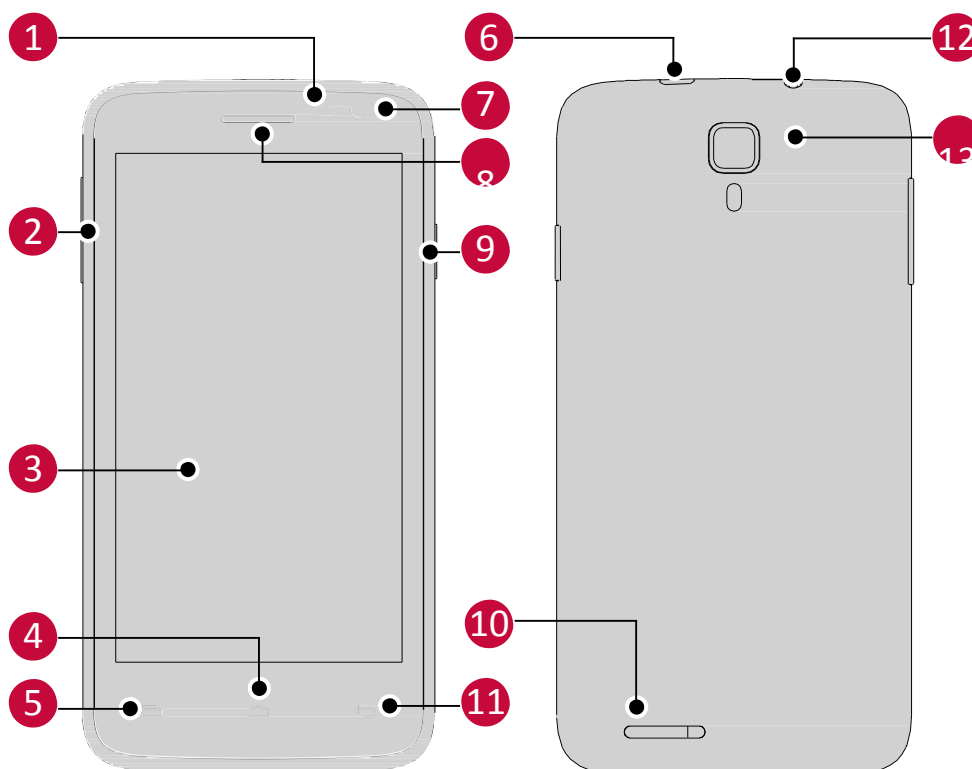

- Prestigio MultiPhone
- Battery
- USB cable
- Adapter
- Quick start guide
- Warranty card
- Legal and safety notices

Your phone at a glance



1	Proximity and light sensor	8	Earpiece
2	Volume button	9	Power button
3	Touch screen	10	Speaker
4	Home key	11	Back key
5	Menu key	12	Earphone jack
6	Micro USB port	13	Rear camera
7	Front camera		

Buttons

Button	Definition	Function
	Power	<ul style="list-style-type: none">• Press and hold to power on or off your phone.• Press to lock or unlock the screen display.
	Volume	<ul style="list-style-type: none">• Press to turn up or lower the volume.
	Menu	<ul style="list-style-type: none">• Tap to open a list of options available on the current screen.• Tap and hold to open the list of recent apps.
	Home	<ul style="list-style-type: none">• Tap to return to the Home screen.
	Back	<ul style="list-style-type: none">• Tap to return to the previous screen.• Tap to hide the on-screen keyboard when it is opened.

2. Getting started



Congratulations on your purchase and welcome to Prestigio. To get the most from your product and enjoy all that Prestigio has to offer, please visit:

<http://www.prestigio.com/catalogue/MultiPhones>

For more details about your product, please visit:

<http://www.prestigio.com/support>



Please read the "MultiPhone legal and safety notices" on your package before use.



- Do not cover the antenna area with your hands or other objects. This may cause connectivity problems or drain the battery.
- Do not allow water to contact the touch screen. The touch screen may malfunction in humid conditions or when exposed to water.

Install the SIM card

Follow the steps below to insert your SIM card. Remember to turn off your mobile phone before removing the rear panel.

1. Securely hold your MultiPhone with your fingers and remove the rear panel.

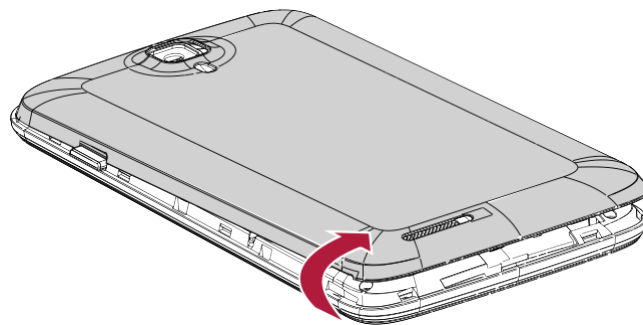

- Be careful not to damage your fingernails when removing the rear panel.
- Do not bend or twist the rear panel excessively. Doing so may damage the cover.

2. With your thumb or any other finger, lift the battery from the battery compartment.

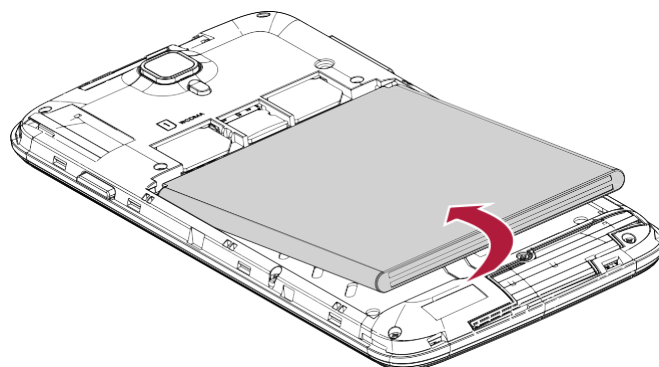

3. With the SIM card's gold contacts facing down and its cut-off corner facing outwards, insert the SIM card all the way into the SIM card slot. Push the SIM card in until it clicks into place.

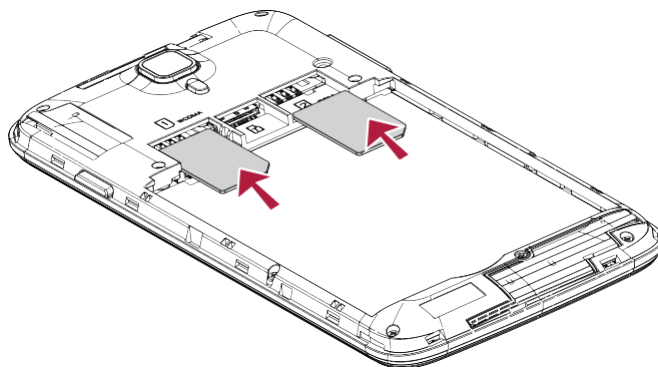

Remove the SIM card: Push the SIM card in to eject it from its slot, and remove it.

Insert a memory card

You can expand the memory of your phone and store more multimedia files by adding a micro-SD card. Depending on the memory card manufacturer and type, some memory cards may not be compatible with your device.

1. Insert a memory card with the gold contacts facing downwards.
2. Push the memory card into the slot until it locks in place.

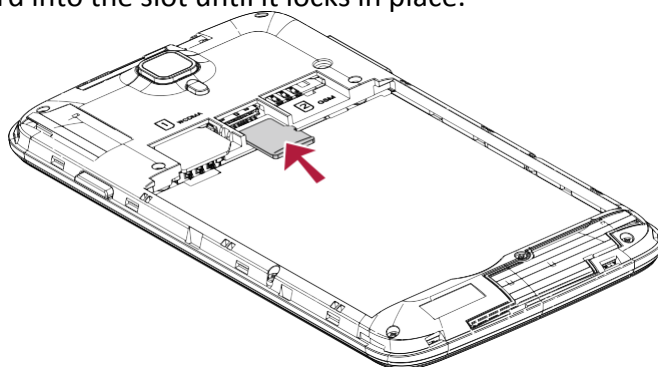

Some memory cards may not be fully compatible with the device. Using an incompatible card may damage the device or the memory card, or corrupt the data stored in it.



- Frequent writing and erasing of data shortens the lifespan of memory cards.
- When inserting a memory card into the device, the memory card's file directory appears in the **ES File Explorer > SD card**.



Remove the memory card: push the memory card until it disengages from the device, and then pull it out.

Insert the battery

Insert the battery (with its exposed copper contacts first) into the battery compartment.

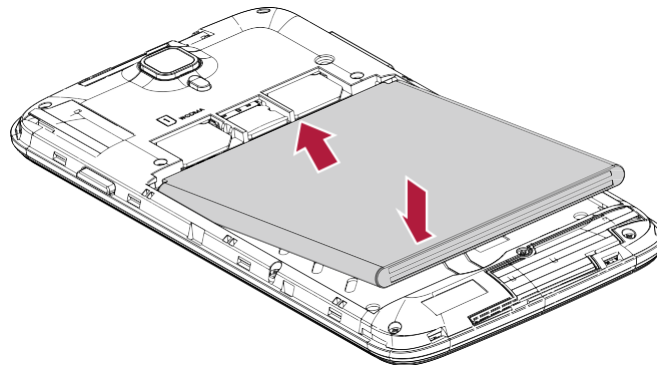

Please use only original batteries that came in the box or replacements that we recommend.

Put the rear panel back

1. Align the rear panel onto the top part of your phone.

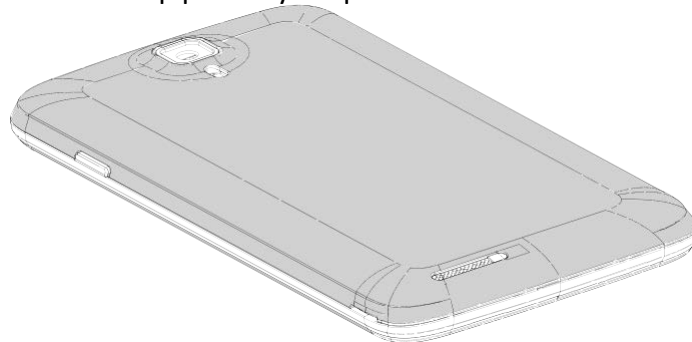

2. Press the sides and the bottom part of the rear panel against your phone to lock the cover into place.

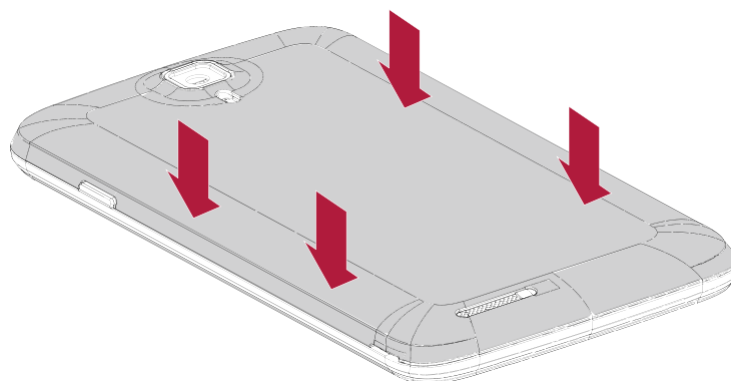

You will hear a click when the rear panel is locked in place.

Power on your phone

Press and hold the power button for a few seconds to power on your phone.

1. When turning on the device for the first time, follow the on-screen instructions to set up your device.
2. After setting up your phone, a Prestigio Installer Wizard will appear on the screen. It offers you a few third-party apps, tap the apps you want to install on your phone. Follow the on-screen instructions to install the apps.
3. It may take a few minutes for your phone to install the apps.



To turn off your phone, press and hold the power button, and then tap **Power off** on the pop-up screen.



If you do not install the apps provided by the Prestigio Installer Wizard the first time, you can tap  on the Home screen to install the apps later.

Home screens

Your Home screen is the starting point to access all of your phone's features. The Home screen can have multiple panels. To view other panels, swipe left or right. Tap  to return to the Home screen. You can add your favourite applications, shortcuts, folders and widgets here so they are always just a tap away. Your phone's Home screen consists of the following:



Personalise your wallpaper

Pick your favourite photo as your Home wallpaper. Choose from the available wallpapers, or use any photo you have taken with the camera.

1. On the Home screen, tap  > **Wallpaper**.
2. Select one of the following: **ES File Explorer**, **Gallery**, **Live wallpapers**, **Video wallpapers** or **Wallpapers**.
3. Select an image and tap **Set wallpaper**. Or, select an image, resize it by dragging the frame, and then tap **OK**.



Add an app icon to Home screen

1. On the Home screen, tap  to open the list menu.
2. Tap and hold an application icon.
3. Drag it into a panel preview.

Remove an item on Home screen

1. Tap and hold an item to remove.
2. The **Remove** option appears at the top of the Home screen.
3. Drag the item to the **Remove** option.
4. When the **Remove** option turns red, release the item.

List menu

All your apps' icons can be found on the list menu. You can also find all the widgets of the apps on the list menu. On the Home screen, tap  to open the list menu. The list menu can have multiple panels. To view other panels, swipe left or right. Tap  or  to return to the Home screen. Your phone's list menu consists of the following:

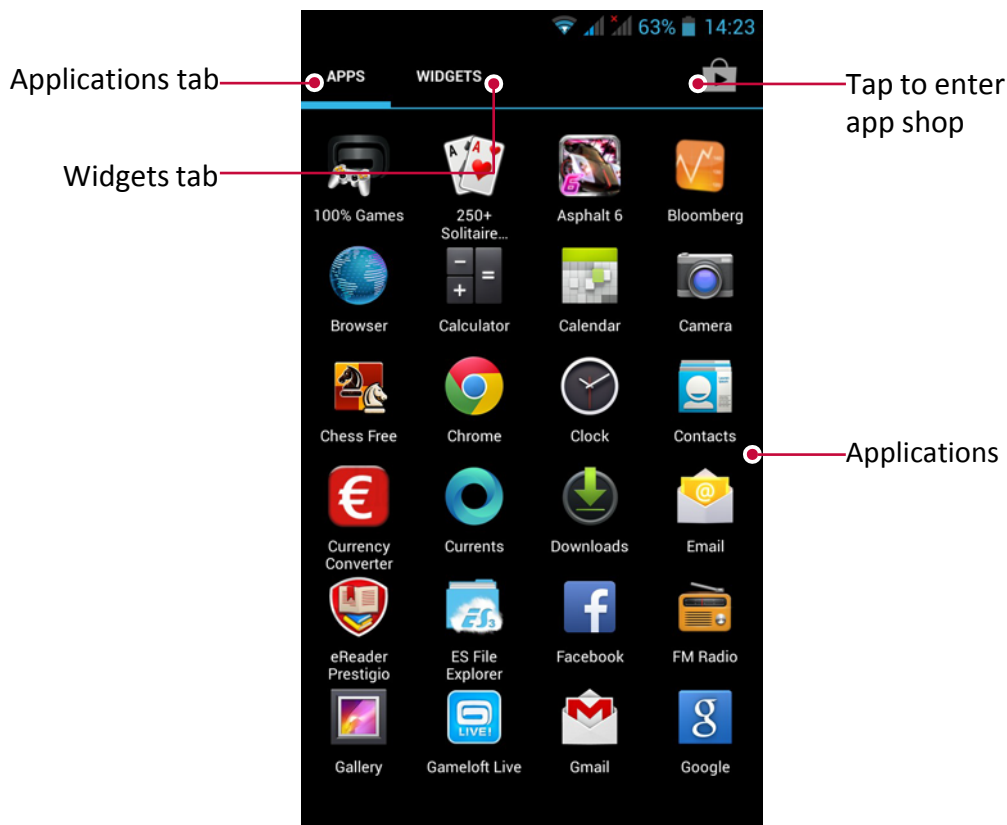

3. Basics

3

Finger tips

Only use your fingers to use the touch screen.

Tap

To open an application, to select a menu item, to press an on-screen button, or to enter a character using the on-screen keyboard, tap it with a finger.

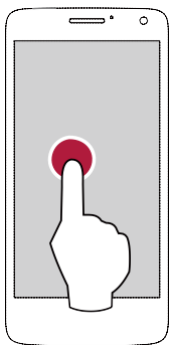

Tap and hold

Tap and hold an item for more than 2 seconds to access available options.



Swipe

Quickly swipe your finger vertically or horizontally across the screen to go to other home pages, scroll through documents, and more.

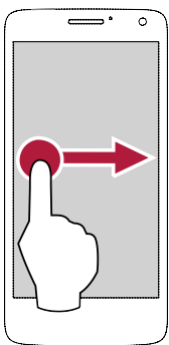

Slide

Slide your finger vertically across the screen to open drop-down menu.

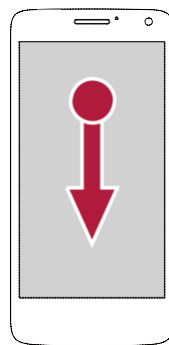

Zoom in

Spread two fingers apart on a web page, map, or image to zoom in a part.

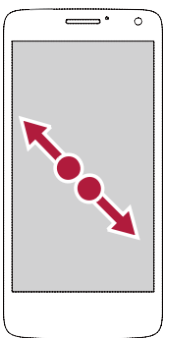

Zoom out

Pinch two fingers together on a web page, map, or image to zoom out a part.

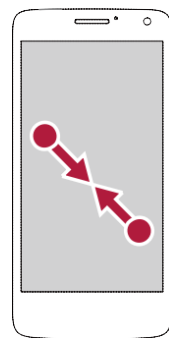

Scroll

Drag up or down to scroll. On some screens, such as web pages, you can also scroll side to side.

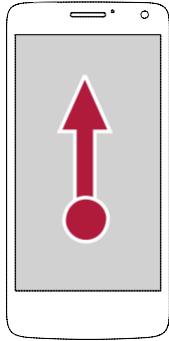

Flick

Flick left or right on the Home screen or the applications screen to see another panel. Flick up or down to scroll through a web page or a list, such as contacts.

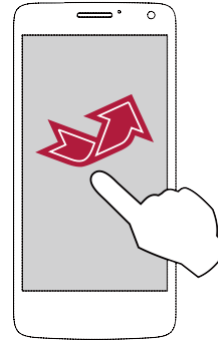

Attention: Excessive pressure on the screen (over 250gr/cm²) prevents correct movement recognition and may cause eventual screen failure. Moves must be light and tangent.

Motion gesture

Rotate your phone for a better view

For many screens, you can automatically change the screen orientation from portrait to landscape by turning your phone sideways. When entering text, you can turn your phone sideways to bring up a bigger keyboard.



To prevent the display from rotating automatically, open the notifications panel and deselect **Auto rotation**.



- Some applications do not allow screen rotation.
- Some applications display a different screen depending on the orientation.

Charge the battery

A new battery is partially charged. The battery icon at the upper-right corner shows the level of charging status.

1. Plug the small end of the charger into the micro USB port of the device, and plug the large end of the charger into an electric socket.

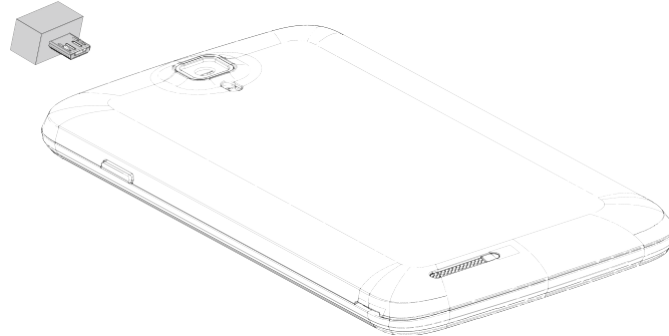

2. After being fully charged, disconnect the device from the charger. First unplug the charger from the device, and then unplug it from the electric socket.



Always use authentic accessories to optimise your battery performance. Non-authentic accessories (eg. chargers) can damage your battery and even your phone.



- You can use the phone while it is charging.
- Keeping the charger plugged to the phone when the battery is fully charged will not damage the battery. The only way to turn off the charger is to unplug it, so it is advised to use an easily accessible power socket.
- If you do not intend to use your phone for several days, we recommend that you remove the battery.
- If a fully charged battery is left unused, it will lose its charge over time.
- If a battery is being used for the first time or the battery has not been used for a prolonged period, it may take longer time to recharge.

Optimise your battery performance

Here are some tips to help you optimise your battery performance.

- Always ensure that your phone profile is appropriately set to meet your actual usage. Profile setting significantly impacts the phone's battery performance. In general, outdoor mode is the most power-draining setting while silent mode consumes the least amount of power.
- If you are not using Bluetooth, Wi-Fi, GPS or other applications, turn them off. And be sure to lock your phone to prevent accidental pressing of the keys with the auto-lock feature.
- Adjust the intensity of your display screen's backlight to low or medium level and for the shortest duration. In general, the lower the backlight level and the shorter the duration, the more power you will save.
- Avoid using or placing your phone near magnetic objects (eg. a radio or television) or on metal surfaces, which will impact the network connection and ultimately drain power from your battery.

Connect to your PC

You may need to connect your phone to a PC in order to complete activation. Your phone's micro USB port allows you to exchange media and other files with a PC.

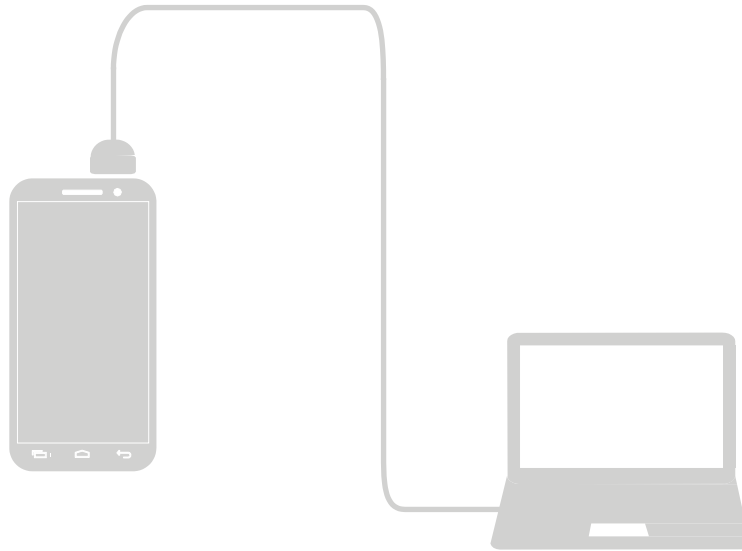

Connect as a media device

1. Connect your phone to the PC with the included USB cable.
2. Open the notifications panel, and then tap **Connected as a media device > Media device (MTP)**.
3. Transfer files between your phone and the PC.

Connect with Windows Media Player

Ensure that Windows Media Player is installed on the PC.

1. Connect your phone to the PC with the USB cable.
2. Open the notifications panel, and then tap **Connected as a media device > Media device (MTP)**.
3. Run Windows Media Player and sync music files.



Tap Camera (PTP) on **USB computer connection** screen if your PC does not support Media Transfer Protocol (MTP) nor have any appropriate driver installed.

Lock and unlock the screen

When not in use, lock your phone to prevent unwanted operations and save the battery power.

- Lock: press the power button.



When your phone is locked, nothing happens if you touch the screen.

Your phone can still:



- Receive calls, text messages, and other updates.
- Play music.
- Adjust the volume.

You can use the earphones to answer a call or listen to music.

- Unlock: press the power button, and then slide the lock icon to unlock your screen.

Auto lock

You can set a time span for the screen to be locked automatically.

1. On the Home screen, tap  to open the list menu.
2. Tap  > **Display > Sleep**.
3. Select your desired time span.



You can also access **System settings** by tapping  on the Home screen or list menu.

Set screen lock pattern



Protect your personal information and prevent others from using your phone without your permission by setting a screen lock pattern, Face Unlock, PIN, or password. You will be asked to unlock the screen every time your phone is powered on or when it is idle for a certain period of time.

1. On the Home screen, tap  to open the list menu.
2. Tap  > **Security** > **Screen lock**.



Setting a slide unlock

1. On the Home screen, tap  to open the list menu.
2. Tap  > **Security** > **Screen lock** > **Slide**.



Setting a Face Unlock

1. On the Home screen, tap  to open the list menu.
2. Tap  > **Security** > **Screen lock** > **Face Unlock**.
3. Fit your face in the frame to be captured.



Setting a voice unlock

1. On the Home screen, tap  to open the list menu.
2. Tap  > **Security** > **Screen lock** > **Voice Unlock**.
3. Follow the prompts to record your voice.



Setting a pattern

1. On the Home screen, tap  to open the list menu.
2. Tap  > **Security** > **Screen lock** > **Pattern**.
3. Draw a pattern by connecting four dots or more, and then draw the pattern again to verify it.

Setting a PIN

1. On the Home screen, tap  to open the list menu.
2. Tap  > **Security** > **Screen lock** > **PIN**.
3. Enter at least four numbers, and then enter the PIN again to verify it.

Setting a password

1. On the Home screen, tap  to open the list menu.
2. Tap  > **Security** > **Screen lock** > **Password**.
3. Enter at least four characters including numbers and symbols, and then enter the password again to verify it.

Unlock your phone

Turn on the screen by pressing the power button, and enter the unlock code.

If you have forgotten your screen lock pattern, you have up to five attempts to try and unlock your phone. If this fails, take the device to your dealer to reset it.

Adjust the volume

Press the volume button to adjust the volume. Press the top of the button to turn up the volume, and press the bottom of the button to lower it.

Recently used apps



You can easily access apps you have just recently opened.

1. Press and hold the menu button  to open the list of recently used apps.
2. Slide your finger up and down to see recently opened apps.
 - To switch back to an app, tap it.
 - To remove an app from the list, swipe it.

Notifications panel



To help make sure you do not miss important events, many apps can provide alerts. An alert can appear briefly as a banner at the top of the screen, which goes away if you do not respond to it, or as a notice in the center of the screen that remains until you acknowledge it.

When you get a new notification, you can open the notifications panel to see what event notification or new information you have received. You can also quickly access settings from the notifications panel.

- To open the notifications panel, slide down from the top of the screen.
- To close the notifications panel, drag up the bar that is at the bottom of the screen.
- To dismiss the notification, tap .
- To enter system settings, tap .

Using Quick Settings

The Quick Settings tab allows you to easily turn airplane mode, Wi-Fi, and other functions on and off. It also provides a quick shortcut to change the mode, set the brightness and auto rotation.

- Tap  or  to switch between notifications and quick settings list.

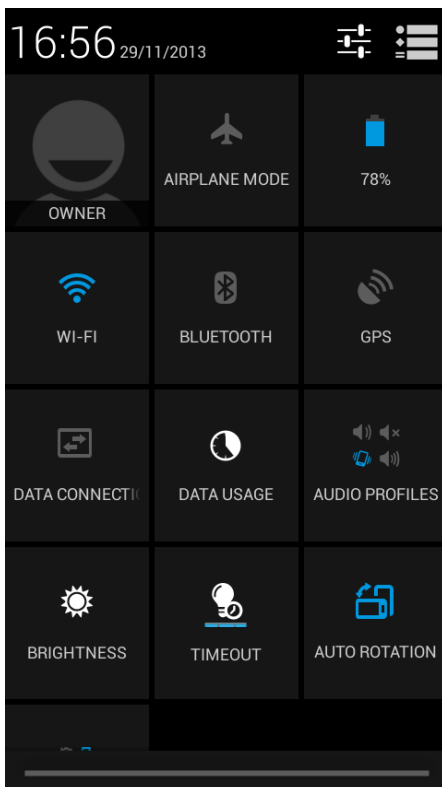

You can view your phone's current status and use the following options:



- Airplane mode: turn on or off your phone's wireless radios.
- Battery: check the battery status.
- Wi-Fi: activate or deactivate the Wi-Fi feature.
- Bluetooth: activate or deactivate the Bluetooth feature.
- GPS: activate or deactivate the GPS feature.
- Data connection: activate or deactivate the data connection.
- Data usage: check the data usage of the data connection.
- Audio profiles: switch to general, silent, meeting or outdoor profiles quickly.
- Brightness: adjust the brightness of the screen.
- Timeout: adjust the screen timeout.
- Auto rotation: allow or prevent the interface from rotating when you rotate the device.
- Air shuffle: turn on or off Air shuffle when you are capturing photos, browsing photos, listening to music or FM radio. You can capture a photo, browse the next photo, listen to next song or channel by moving you hand. The sensor is behind the front camera.

Enter text

Use the on-screen keyboard to enter text, such as contact information, mail, and web addresses. Depending on the app and the language you are using, the keyboard may correct misspelled words, predict what you are typing, and even learn as you use it.

Change the input method

You can download an input app or use the input method pre-installed on your phone. To change the input method, follow these steps:

1. On the Home screen, tap  to open the list menu.
2. Tap  > **Language & input** > **Default**.
3. Choose the desired input method.



Use the Prestigio keyboard

Tap a text field to bring up the keyboard, and then tap keys on the keyboard. You can enter text with the built-in QWERTY keyboard.



Enter text

As you type, each letter appears above your thumb or finger. The letter is not entered until you choose your desired word.

- Type uppercase: tap the Shift key  before tapping a letter. Or touch and hold the Shift key, then tap a letter.
- Type lowercase: tap the Shift key again and then tap a letter.
- Enter numbers, symbols or punctuation: tap .

Enter text by voice

You also can enter the text by activating the voice input feature and then speak into the microphone. Your phone displays what you speak.

Voice typing: open the Prestigio keyboard, tap .

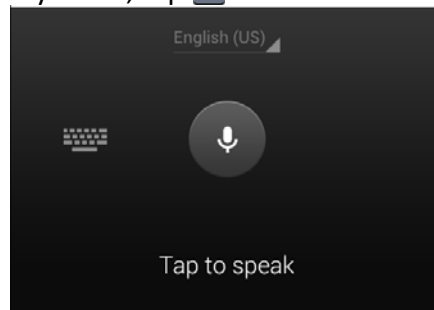

- If the device does not recognise your words correctly, tap the underlined text and select an alternative word or phrase from the dropdown list.
- To change the language or add languages for the voice recognition, tap  and select **Add more languages**.

Copy and paste text

1. After you have selected the text you want to copy, tap . The selected text is then copied to the clipboard.
2. In a text entry field, press and hold at the point where you want to paste the text.
3. Tap **Paste**.

Move a text

1. After you have selected the text you want to cut, tap . The selected text is then cut to the clipboard.
2. In a text entry field, press and hold at the point where you want to paste the text.
3. Tap **Paste**.



You can tap  to select all the text you have entered.

Use widgets

Widgets put at-a-glance important information and media content up front on your Home screen. Some widgets are already added to your Home screen for your convenience. You can add more from the available selections of widgets.

Add a widget to Home screen

1. On the Home screen, tap  to open the list menu.
2. Tap **WIDGETS** to open the widgets list.
3. Scroll left or right on the widgets panel.
4. Tap and hold the desired widgets to add it to the Home screen.



- Some widgets connect to web services. Using a web-based widget may result in additional charges.
- The widgets available may vary depending on the region or the service provider.

System upgrade

Your phone can check and notify you if there is a new upgrade available. You can also manually check if there is an available update.

You can set this option in **Settings > About phone > System updates**.



Do not press any buttons while the device is upgrading.

Status icons

The icons in the status bar at the top of the screen give information about your phone:





Icons	What it means	Icons	What it means
	Silent mode activated.		3G network connected.
	Vibration mode activated.		Wi-Fi connected.
	Airplane mode activated.		Roaming (outside of normal service area).
	Battery power level.		Bluetooth is activated.
	Call in progress.		Connected to PC.
	Missed call.		Wired earphone + microphone connected.
	New SMS or MMS.		Wired earphone connected
	GPRS network connected.		No SIM card detected.
	EDGE network connected.		Alarm is set.
	HSPA network connected.		

4 . Phone

4

Learn to use calling functions, such as making and answering calls, using options available during a call or customising and using call-related features.

Make a call

1. Tap  to open the dial pad, enter your number directly. Or enter the first few digits of a phone number, then choose a contact.
2. Tap .

You also can use the following methods to make a call:

- Make a call from the history of incoming and outgoing calls and messages.
- Make a call from the contacts list.
- Make a call from the list of favourite contacts.



The phone dialler's SmartDial features makes it quick and easy for you to make a call. Simply enter the phone number or first few letters of the person's name you want to call. SmartDial automatically searches and filters your stored contacts and the phone numbers from the call history.

Answer a call

When you receive a phone call from a contact, the incoming call screen appears. To pick up the phone, do the following:





- Slide  to .



- If there is a headset connected to your phone, you can pick up a call by pressing the center button of your headset.
- If the call waiting service is active, another call can be made. When the second call is answered, the first call is put on hold.

Reject a call

When a call comes in, do the following to reject the call:

- Slide  to , reject the call immediately.
- Slide  to , you can send a message to the caller or create a task for returning the call.
 - Press the power button or volume button to mute the ringing sound without rejecting the call.

End a call



Tap  to end a call. Or press the center button of your headset.

Contacts



Contacts are stored in one of the two available phone books: SIM phone book (located on your SIM card, by which the number of entries you can store depends on its capacity) or the Smart phone book (located on your phone). When adding new contacts, the contacts will only be added to the phone book you have selected.

View contacts



Do the following methods to view the contact list:

- On the Home screen, tap .
- Or on the list menu, tap .

Search for a contact



1. Go to  to view the contact list.
2. Scroll up or down the contact list.
3. Tap  and enter the first few letters of the name in the search bar.
4. Select the contact from the option list.

Call a contact



1. Go to  to view the contact list.
2. Scroll the list to select your desired contact.
 - Tap the number area to call the contact.
 - Tap  to make a video call with the contact.

Add a new contact

Method one:

1. On the Home screen, tap  to display the dial pad.
2. Enter a number, tap  > **Add to contacts**.
3. Tap **Create new contact**, select your desired storage.
4. Add details as desired.
5. Tap **Done** to finish and save.

Method two:

1. Go to  to view the contact list.
2. Tap  to add a new contact.



For contacts on the smart phone book, you can add detailed information, like home number, office number, contact pictures and etc.



My favourites

Add a contact to favourites

You can add contacts from your smart phone book to favourites.

1. Search for the desired contact.
2. Tap  to add the contact to your favourites.





View your favourites

1. Go to  to view the contact list.
2. Tap  to view your favourites.



Contact groups

You can group your contacts as different groups. For different groups, you can use different identifications, and send messages to a group.



Add contacts to a group

1. Go to  to view the contact list.
2. Tap  to view contact groups.
3. Tap  to add contacts to a group.
4. Enter your group's name, and tap  to add contacts.

Import/Export contacts

1. Go to  to view the contact list.
2. Tap  > **Import/export**.
3. Select the contacts storage.
4. Follow the prompts to finish.

Delete contacts

1. Go to  to view the contact list.
2. Tap  > **Delete contact**.
3. Choose the contacts you wish to remove.
4. Tap **OK** to delete the contacts.



Use speed dial

Use speed dial to call a phone number with a single tap. For example, if you assign a contact's number to the number 2 key, you can just press and hold 2 to dial the number.



The number 1 key is generally reserved for your voice-mail. Press and hold this key to call voice-mail and retrieve your voice-mail messages.

To assign a contact to a speed dial key

1. On the Home screen, tap  to display the dial pad.
2. Tap  > **Speed dial**.
3. Choose a numeric key.
4. Tap the desired contact from your phone book.

Call a phone number in a text message

1. Tap the phone number within the message.
2. Tap  to call the number.



To call the message sender, tap  on the top of your screen.

Call a phone number in an e-mail





1. Tap the phone number in the e-mail body.
2. Tap  to call the number.

Set up a conference call

If network is available, you can make the first call or accept a call. Then simply dial each subsequent call to add it to the conference.



Make sure your SIM card is enabled with conference calling service. Contact your mobile operator for details.



1. During a call, tap  to enter a phone number or select a contact from your phone book.
2. Tap  to dial the number.
3. The second number is dialled, and the first call is put on hold at this time.
 - You can tap  to toggle between 2 calls.
 - Tap  to add the contact to a conference call.

Make an emergency call

In some regions, you can make emergency calls even if you do not have a SIM card installed or your SIM card has been blocked.



If you are out of base station coverage, you will not be able to make an emergency call.

1. On the Home screen, tap  to open the dial pad.
2. Dial the emergency number for your location, and then tap .







In Europe, the standard emergency number is 112; in the UK, it is 999.

5. Messages

5

Messages let you exchange text messages with other SMS and MMS devices via your cellular connection. Your sent and received messages are neatly grouped into conversations, by contact name or phone number.

Send a message

1. On the Home screen or list menu, tap .
2. Tap  to start composing a new message.
3. Use the following methods to add recipients:
 - Enter a phone number.
 - Tap , select contacts, and then tap **OK**.
4. Enter the text message in the text box.
5. Tap  to add picture/video/audio/slideshow if you want to send an MMS message.
6. Tap  to send the message.



After you finish entering your text, you can just tap  to save the message as a draft.



- There is a limit on the number of characters for a single text message (displayed above the send button). If you exceed the limit, your text message will be delivered as one but will be billed as more than one message.
- Your text message automatically becomes a multimedia message if you enter an e-mail address as the recipient, add a message subject, attach an item, or compose a long message.

Check your message

Depending on your notification settings, your phone plays a sound, vibrates, or displays the message briefly in the status bar when you receive a new message. A new message icon is also displayed in the status bar. Incoming messages are grouped into message threads by contact.

Check your text message

- Open the notifications panel, and then tap the new message notification.
- Go to the messages app and open the message.

Listen to a voice message



When you receive a voice message, check the message and tap  to start voice playback.

Reply to a message

1. On the messages screen, tap a contact (or phone number) to display the exchange of messages with that contact.
2. In the text box, enter your message.
3. Tap  to send the message.

Forward a message

1. On the messages screen, tap a contact (or phone number) to view the exchange of messages with that contact.
2. Tap and hold a message.
3. In the pop-up window (**Message options**), select **Forward**.



4. Use the following methods to add recipients:
 - Enter a phone number.
 - Tap , select contacts, and then tap **OK**.
5. Enter more text if you want.
6. Tap  to send the message.

Delete your messages

Delete a message



1. On the Home screen or list menu, tap .
2. The messages screen is displayed.
3. Tap a contact (or phone number) to view the exchange of messages with that contact.
4. Tap and hold a message.
5. In the pop-up window (**Message options**), select **Delete**.

Delete a conversation

1. On the Home screen or list menu, tap .
2. The messages screen is displayed.
3. Tap and hold a contact or phone number.
4. Tap  at the bottom of the screen.

Create a conversation shortcut

You can create a shortcut for the conversation, do the following:

1. On the Home screen or list menu, tap .
2. The messages screen is displayed.
3. Tap and hold a contact or phone number.
4. Tap  at the bottom of the screen.
5. Then you can find the shortcut on your Home screen.



WAP push messages

WAP push messages contain a web link. Often, the link is to download a file that you have requested from a service provider. When you receive a WAP push message, a notification icon is displayed in the status bar.

Read a new WAP push message

1. Open the notifications panel, and then tap the push message notification.
2. Tap **Visit website**.

View all your WAP push messages

1. On the Home screen or list menu, tap .
2. Tap  > **Wappush messages**.



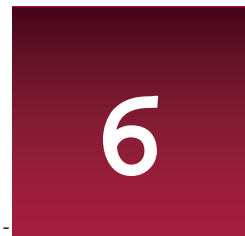

You can only see this option if you have previously received WAP push messages.

6. Mail



Use this application to send or view e-mail messages. Learn to send or view e-mail messages via your personal or company e-mail account.

Set up an e-mail account

1. On the Home screen or list menu, tap  and do one of the following:
 - If this is your first time adding an e-mail account in Mail, move to the next step.
 - If you have already added an e-mail account, then tap  > **Settings** > **ADD ACCOUNT**.
2. Enter the e-mail address and password for your e-mail account.
3. Tap **Next** for a private e-mail account, or tap **Manual setup** for a company e-mail account.
4. Follow the prompts to complete the setup.







When you finish setting up the e-mail account, the e-mail messages will download to your device.







Consult your mail service provider for the mail server configuration.

Send a mail

1. On the Home screen or list menu, tap .
2. Switch to the e-mail account that you want to use.
3. Tap .
4. Fill in one or more recipients.
 - If you want to loop in more recipients in a carbon copy (Cc) or blind carbon copy (Bcc) of the e-mail message, tap  > **Add Cc/Bcc**.
5. Enter the subject, and then compose your mail.
 - Add an attachment: tap  > **Attach file** and then choose the files you want to send out.
6. Tap  to send the mail.



View your mails

1. On the Home screen or list menu, tap .
2. Switch to the e-mail account that you want to use.
3. The mail inbox will be displayed on the screen.
4. Tap  to check whether there is a new mail.
5. Tap the desired mail to read it.
 - Use  or  to view the previous or next mail.





Unread e-mail messages are displayed in bold and color bars appear next to them.



Search for a mail

1. On the Home screen or list menu, tap .
2. Switch to the e-mail account that you want to use.
3. Tap  to display the search bar.
4. Choose a search option in the drop-down list.
5. Enter the first few letters of the mail sender or subject in the search bar.
6. Select the mail from the list.

Reply to a mail

1. On the Home screen or list menu, tap .
2. Switch to the e-mail account that you want to use.
3. In the inbox, tap the e-mail message.
4. Tap , and then compose your mail.
5. Tap  to send the mail.

Delete mails



1. On the Home screen or list menu, tap .
2. Switch to the e-mail account that you want to use.
3. Tap the mail you wish to delete, and then tap .

Gmail

Use this application to quickly and directly access the Google Mail service.

View your Gmail Inbox

All your received e-mail messages are delivered to your Inbox.

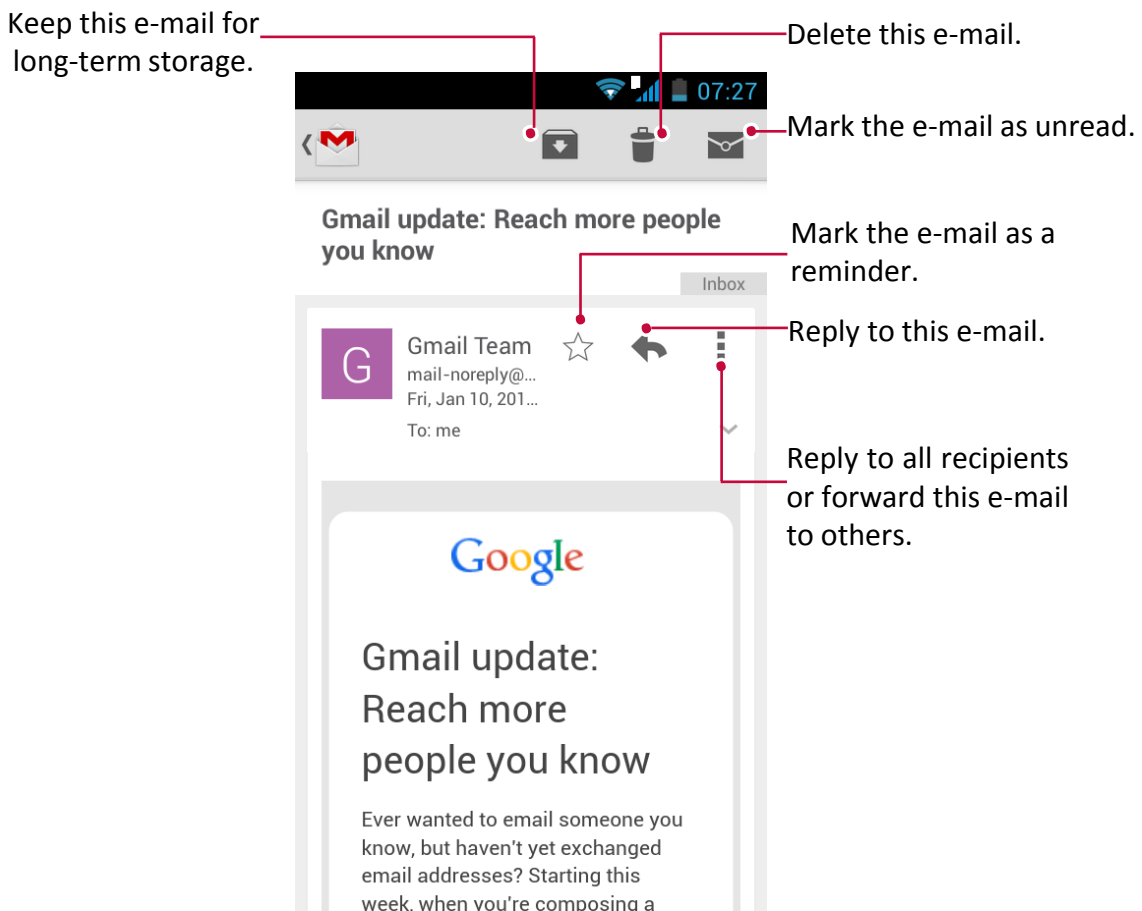

1. On the Home screen or list menu, tap .
2. Your mail inbox is displayed on the screen.
3. Tap  > **Refresh** to check whether there is a new mail.
4. Tap the desired mail to read it.
5. Swipe left or right to view the previous or next mail.





Search for a mail

1. On the Home screen or list menu, tap .
2. Tap  to display the search bar.
3. Enter the first few letters of the mail sender or subject in the search bar.
4. Select the mail from the list.



Send a mail in Gmail

1. On the Home screen or list menu, tap .
2. Tap .
3. Fill in one or more recipients.
 - If you want to loop in more recipients in a carbon copy (Cc) or blind carbon copy (Bcc) of the e-mail message, tap  > **Add Cc/Bcc**.
4. Enter the subject, and then compose your mail.
 - Add a picture or file: tap  > **Attach picture/Attach file**.
5. Tap  to send the mail.

Reply to a mail in Gmail

1. On the Home screen or list menu, tap .
2. In the e-mail account inbox, tap the e-mail message.
3. Tap , and then compose your mail.
4. Tap  to send the mail.

Delete mail in Gmail

1. On the Home screen or list menu, tap .
2. Tap the desired mail, and then tap .

7. Camera



With your phone, you can take both photos and videos as desired. In addition to a rear camera, there is a camera on the front for video calls and self-portraits. An LED flash on the back gives you extra light when you need it.

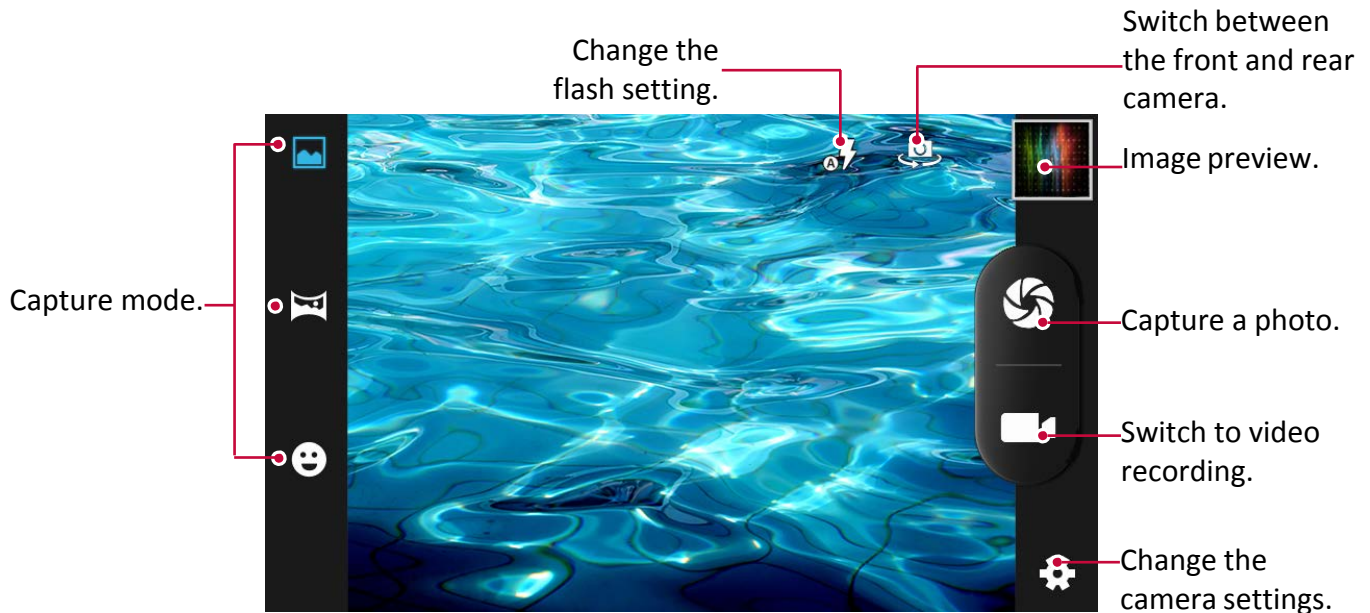

- To use the camera, on the Home screen or list menu, tap .

Your camera at a glance





Select capture mode



While using your camera, you can scroll down to select your desired capture mode. You can choose the following capture modes:

-  Take a single photo.
-  Take a panoramic photo. You can take a photo composed of many photos strung together.
-  Auto capture when smile is detected.





Take a photo

1. Tap  to turn on the camera.
2. Spread or pinch the screen to zoom in or out.
3. Change the camera setting if necessary.
4. Point the camera at what you want to capture. The camera will adjust the focus automatically as you move it.
5. Tap  to capture the photo.

Take a photo of yourself



1. Tap  to turn on the camera.
2. On the screen, tap .
3. Tap  to capture the photo.

Set self timer

1. Tap  to turn on the camera.
2. Tap  to customise your camera.
3. On the pop-up window, tap  > **Self timer**, select your time span.
4. When you are ready to take a photo, tap . The photo will be captured after the set time span.

Take a panoramic photo





You can capture anything wide or tall objects in a single photo with your phone.

1. Tap  to turn on the camera.
2. Scroll down the capture modes, and then tap .
3. When you are ready to take the first shot, tap . Directional arrows appear, prompting you to pan left or right in landscape view (or pan up or down in portrait view).
4. Pan your phone as smoothly as you can, and then pause when you see a complete frame on the Viewfinder screen. The camera will automatically capture the shot.
5. Repeat the previous step to take the remaining shots.
6. The camera will stitch the shots into a single photo.





 Zoom and flash are disabled when you are in this mode.

Take continuous shots

You can take continuous shots by holding the capture icon. Make sure that you are in normal capture mode by tapping .



1. Tap  to turn on the camera.
2. Tap  to customise your camera.
3. On the pop-up window, tap  > **Continuous shot**, select your desired shots.
4. When you are ready to take the photo, tap and hold .
5. To save more photos from the batch, just delete the photos you do not want to keep.

Record a video

1. Tap  to turn on the camera.
2. When you are ready to start recording, tap .
3. While recording, you may choose to do the following:
 - Zoom in or out.
 - Change focus to a different subject or area by tapping it on the Viewfinder screen.
 - Tap the flash icon to turn the flash on or off.
 - Tap  to pause the video recording.
 - To capture an image from the video while recording, tap .
4. To stop recording, tap .





Camera scenes

A scene is a collection of settings to suit the lighting and environment. Use normal mode and let the camera automatically determine the optimal settings, or choose from a wide selection of scenes before you take a photo. Predefined settings make point-and-shoot photos easier to take.

1. Tap  to turn on the camera.
2. Tap  to customise your camera.
3. On the pop-up window, tap  > **Scene mode**.

Camera and video settings

Before you take a photo or record a video, customise your camera settings.

1. Tap  to turn on the camera.
2. Tap  to customise your camera.
3. On the pop-up window, tap // to switch among general settings, camera and video settings. The available options vary depending on the mode used.
 - **GPS location info:** Attach a GPS location tag to the photo.
 - **Exposure:** This determines how much light the camera's sensor receives. For lowlight situations, use a higher exposure.
 - **Color Effect:** Select among various photo effects to suit your needs.
 - **Scene mode:** Select your desired scene mode.
 - **White balance:** Select an appropriate white balance, so images have a true-to-life colour range. The settings are designed for specific lighting situations. These settings are similar to the heat range for white-balance exposure in professional cameras.
 - **Anti-flicker:** Select a band to avoid the impacts on photos caused by flickers from lighting sources.
 - **Restore defaults:** Restore to default settings.
 - **Face detection:** Set the ideal exposure and clarity of faces.
 - **Self timer:** Select a time span for shutter delay to take a self-portrait.
 - **Continuous shot:** Allows you to take several photos in quick succession.
 - **Picture size:** Select from various standard sizes for your picture.
 - **Preview size:** Set the preview screen ratio before you take a photo.
 - **EIS:** The EIS (Electronic Image Stabilization) function helps reduce blurring associated with the motion of a camera during exposure.
 - **Microphone:** Enable or disable microphone while recording a video.
 - **Audio mode:** Select an audio mode for your video.
 - **Time lapse interval:** Set the time lapse interval to adjust the speed of your video output.
 - **Video quality:** Set the quality level for videos as this setting will affect your file size.



- To improve GPS signals, avoid shooting in locations where the signal may be obstructed, such as between buildings or in low-lying areas, or in poor weather conditions.
- Your location may appear on your photos when you upload them to the Internet. To avoid this, deactivate the GPS location info.

8. Multimedia

8

Your phone provides several multimedia for your entertainment. You can view your photo gallery, enjoy music, and watch videos.

Gallery

Use **Gallery** to view all your photos and videos on your phone.



- To open your Gallery, on the Home screen or list menu, tap .





- Some file formats may not be supported depending on the software installed on your device.
- Some files may not display properly depending on their encoding.

View your photos

View photos in the album



1. On the Home screen or list menu, tap .
2. Tap  to open a drop-down list, and then tap **Albums**.
3. Browse an album or a group of photos.
4. Tap a photo to view it full-screen.

View photos by locations

1. On the Home screen or list menu, tap .
2. Tap  to open a drop-down list, and then tap **Locations**.
3. Pinch the screen or pan across the map until (location indicator) appears. The location indicator shows how many photos are taken in that area. Only photos with geo-tag info will appear on the map.
4. Tap the location indicator. The photos taken in the same area will be displayed.

View photos by time

View photos and videos based on when they were taken.



1. On the Home screen or list menu, tap .
2. Tap  to open a drop-down list, and then tap **Time**. Photos and videos stored in your phone will be displayed according to the time they were taken.
3. Tap the sorted photos by a time. All the photos taken around that time will be displayed.

Zoom in and out



Use one of the following methods to zoom in or zoom out an image:

- Double-tap anywhere to zoom in.
- Spread two fingers apart on any place to zoom in. Pinch to zoom out, or double-tap to return.

Start a photo slideshow

1. On the Home screen or list menu, tap .
2. Browse to select an album or a group of photos.
3. Tap  > **Slideshow**.

Watch a video



1. On the Home screen or list menu, tap .
2. Go to one album in Gallery, select the video that you want to watch.
3. Tap the on-screen keys to control the video playback.
4. Press the volume button to adjust the sound.
5. Tap  for more options.

Edit your photos

When viewing a photo, tap  to use the following functions:

- **Delete:** Delete the photo.
- **Slideshow:** Start a slideshow with images in the current folder.
- **Edit:** Launch Paper Artist to edit a photo.
- **Rotate left:** Rotate anticlockwise.
- **Rotate right:** Rotate clockwise.
- **Crop:** Resize the orange frame to crop and save your photo.
- **Set picture as:** Set a photo as your wallpaper or a contact image.
- **Details:** Check information of the photo file.

Crop a photo

1. On the Home screen or list menu, tap .
2. Select the photo that you want to edit.
3. Tap  > **Edit**, and then tap  > **Crop**. You will see a crop box around the photo.
 - Drag the crop box over the part of the photo you want to keep.
 - Press the edge of the crop box, and drag your finger inward or outward to resize the photo.

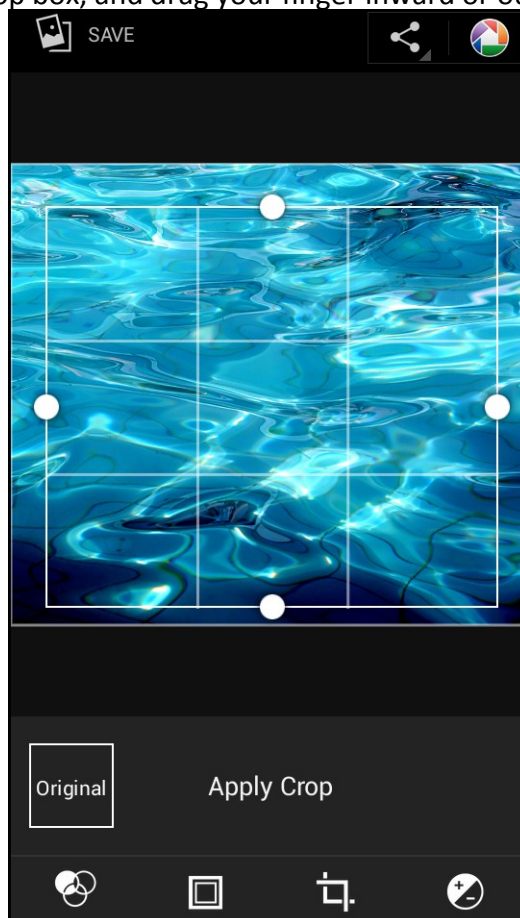



4. Tap **Save**.



The cropped photo is saved as a copy. The original photo remains unedited.

Add photo effects

1. On the Home screen or list menu, tap .
2. Select the photo that you want to edit.
3. Tap  > **Edit**, and then tap .
4. Tap an effect to apply to the photo.
5. Tap **Save**.





The enhanced photo is saved as a copy. The original photo remains unedited.

Share your photos

You can share your photos with another device via e-mail, MMS or Bluetooth.



Share photos by E-mail

1. On the Home screen or list menu, tap .
2. Select the photo(s) that you want to share.
3. Tap  to open a drop-down list, and then tap **E-mail**.
4. Choose an e-mail account.
5. Compose your message.
6. Tap  to send the mail.





If you have multiple e-mail accounts, the default e-mail account will be used.

Share photos by MMS

1. On the Home screen or list menu, tap .
2. Select the photo(s) that you want to share.
3. Tap  to open a drop-down list, and then tap **Messaging**.
4. Enter a phone number or add a contact from your phone book.
5. Compose your message.
6. Tap  to send the message.



Share photos via Bluetooth

1. On the Home screen or list menu, tap .
2. Select the photo(s) that you want to share.
3. Tap  to open a drop-down list, and then tap **Bluetooth**.





You will be asked to turn on Bluetooth and connect to the receiving Bluetooth device so the files can be sent.

Delete photos

1. On the Home screen or list menu, tap .
2. Select the photo(s) that you want to delete.
3. Tap , and then tap **delete**.

Set as wallpaper or contact photo



1. On the Home screen or list menu, tap .

2. Select the desired photo.
3. Tap , and then tap **Set picture as**.
4. Select **Wallpaper** or **Contact photo**.
5. You will see a crop box around the photo.
 - Drag the crop box over the part of the photo you want to keep.
 - Press the edge of the crop box, and drag your finger inward or outward to resize the photo.
6. Tap **OK** to set the photo as your wallpaper or contact photo.

Video player

You can use the video player on your phone to watch videos.



Watch a video with the video player

1. On the Home screen or list menu, tap .
2. Select the video that you want to watch.
3. Tap the on-screen keys to control the video playback.
4. Press the volume button to adjust the sound.
5. Tap  to select more options.

Share your videos

You can share your videos with another device via e-mail, MMS or Bluetooth.



Share videos by E-mail

1. On the Home screen or list menu, tap .
2. Select the video(s) that you want to share.
3. Tap  to open a drop-down list, and then tap **E-mail**.
4. Choose an E-mail account.
5. Compose your message.
6. Tap  to send the mail.





If you have multiple e-mail accounts, the default e-mail account will be used.

Share videos by MMS

1. On the Home screen or list menu, tap .
2. Select the video(s) that you want to share.
3. Tap  to open a drop-down list, and then tap **Messaging**.
4. Enter a phone number or add a contact from your phone book.
5. Compose your message.
6. Tap  to send the message.

Share videos via Bluetooth

1. On the Home screen or list menu, tap .
2. Tap the video that you want to share.
3. Tap  to open a drop-down list, and then tap **Bluetooth**.



You will be asked to turn on Bluetooth and connect to the receiving Bluetooth device, so the files can be sent.

Music player

You can listen to your favourite music with the music player. The music app is a central hub for your favourite music whether it is stored in your phone or streamed through a music service.

- To use the music player, on the Home screen or list menu, tap .



- Some file formats are not supported depending on the device's software version.
- Some files may not play properly depending on the encoding used.

Browse music

1. From the Home screen, tap .
2. You can:
 - Tap **Artists/Albums/Playlists** to browse songs sorted by artists, albums, or playlists.
 - Tap **Songs** to browse all songs.
 - Tap **Now playing** to check the song that is playing now.



The **Now playing** selection is only available in landscape view.

Listen to music

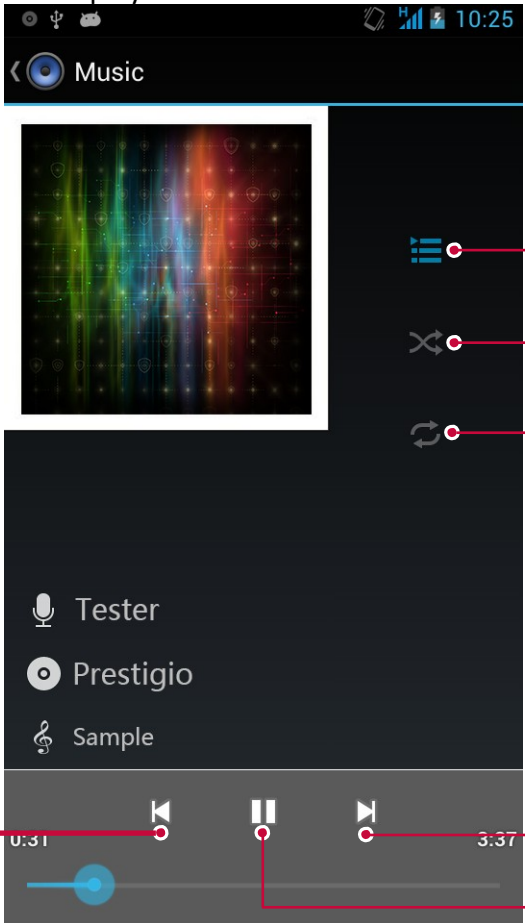

1. On the Home screen or list menu, tap .
2. Tap a song from the list.
3. Use the following keys to control playback:



The screenshot shows the music player interface with the following controls and annotations:

- Back to current playlist:** A red line points from the text to the playlist icon (three horizontal lines) on the right side of the screen.
- Turn on shuffle:** A red line points from the text to the shuffle icon (two crossed arrows) on the right side of the screen.
- Select play mode: Repeat one, Repeat all or Off:** A red line points from the text to the repeat icon (two circular arrows) on the right side of the screen.
- Skip to the previous song. Tap and hold to move backwards quickly:** A red line points from the text to the previous song button (left arrow) at the bottom of the screen.
- Pause and resume playback:** A red line points from the text to the pause button (two vertical bars) at the bottom of the screen.
- Skip to the next song. Tap and hold to move forwards quickly:** A red line points from the text to the next song button (right arrow) at the bottom of the screen.



Set a song as ringtone

1. On the Home screen or list menu, tap .
2. Tap a song from the list.
3. Tap  and select **Use as ringtone**.

Your playlist

Create a playlist

You can make your own playlist.

1. On the Home screen or list menu, tap .
2. Tap a song from the list.
3. Tap  and select **Add to playlist**.
4. On the pop-up screen, tap **New** to create a new playlist.
5. Enter a title and tap **Save**.



Rename the playlist

1. On the Home screen or list menu, tap .
2. Tap **Playlists** to view all your playlists.
3. Tap and hold the playlist you want to rename.
4. Select **Rename** on the pop-up screen.

Delete a playlist

1. On the Home screen or list menu, tap .
2. Tap **Playlists** to view all your playlists.
3. Tap and hold the playlist you want to delete.
4. Select **Delete** on the pop-up screen.

Delete a song

1. On the Home screen or list menu, tap .
2. Tap a song from the list.
3. Tap  and select **Delete**.

FM radio



You can listen to radio programs with your phone.

- To use the FM radio, on the Home screen or list menu, tap .



You must connect a headset before using the FM radio on your phone.

Listen to a radio station

1. On the Home screen or list menu, tap .
2. Tap  > **Search**. It will start scanning automatically and save the available channels.
3. Use the following keys to control playback:

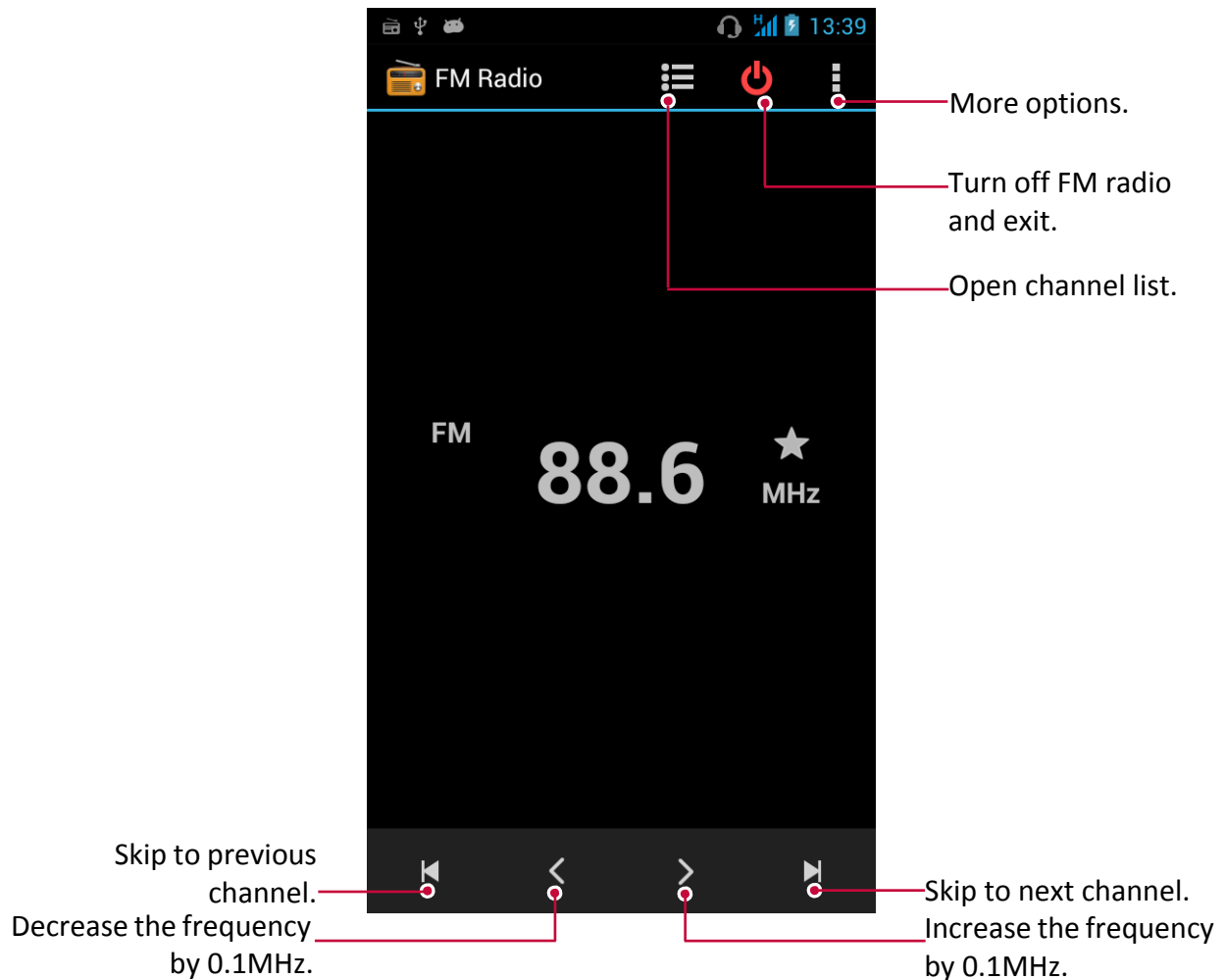



Turn off FM

- You can use other apps while listening to the radio.
- To turn off FM Radio completely, tap .

Record radio programs





You can record a radio program when listen to it.

1. On the Home screen or list menu, tap .
2. Tune to your desired radio station.
3. Tap  > **Record FM**.
4. Tap  to stop recording.
5. Enter a name for the recording and tap **Save**.

Voice recorder

Use Voice Recorder to capture information during lectures, interviews, or even to create your own audio log.



Record a voice memo

1. On the Home screen or list menu, tap .
2. Hold the microphone near the sound source.
3. Tap  to start recording a voice clip.
4. Tap  to pause voice recording. (Tap  to resume voice recording.)
5. Tap  to stop recording.
6. Tap **Save**.





Voice Recorder can run in the background while you do other things on your phone, except when you open other apps that also use audio functions.

Play a voice memo

1. On the Home screen or list menu, tap .
2. Tap  to open the recorded files list.
3. Tap your voice memo to play it.

Delete a voice memo

1. On the Home screen or list menu, tap .
2. Tap  to open the recorded files list.
3. Tap and hold the voice memo you want to delete.
4. Tap  to delete the file.

9. Web & network

9

You can connect your phone to the Internet and browse a web page.



Connect to the Internet



Your phone connects to the Internet whenever necessary, using a Wi-Fi connection (if available) or your mobile operator's data connection.

Data connection

You can use your mobile operator's data connection. Some apps and services may transfer data over your mobile operator's cellular network, which may result in additional fees. Contact your mobile operator for details.

Turn on or off data connection

1. On the Home screen or list menu, tap .
- Or, tap  > **System settings**.
2. Tap **More...** > **Mobile networks** > **Data connection**.
3. Tap to turn on or off data connection.





 You can tap to turn on or off data connection on notifications panel. On notifications panel, tap  to switch to quick settings list, and then tap **Data connection**.

 If you do not have the data connection turned on and you are also not connected to a Wi-Fi network, you will not receive automatic updates to your e-mail, social network accounts, and other synced information.

Add a new access point

Access Point Names (APNs) connect your phone to data networks for services such as mobile web browsing.



 Before you add another data connection, have the access point name and settings from your mobile operator ready (including username and password if required).

1. On the Home screen or list menu, tap .
- Or, tap  > **System settings**.
2. Tap **More...** > **Mobile networks** > **Access Point Names**.
3. On the APNs screen, tap  > **New APN**.
4. Enter the APN settings.
5. Tap  > **Save**.
6. Select the new APN on the APNs screen.

Turn on or off data roaming

Connect to your mobile operator's partner networks and access data services when you are out of your mobile operator's coverage area.

 Using data services while roaming may be costly. Check with your mobile operator for data roaming rates before you use data roaming.

1. On the Home screen or list menu, tap .
- Or, tap  > **System settings**.
2. Tap **Data usage**.
3. Tap  > **Data roaming** to turn it on or off.

Keep track of your data usage



If you are on a limited data allowance, it is important to keep track of the activities and apps that send and receive data, such as browsing the web, syncing online accounts, and receiving e-mails or sharing status updates.





To help you save on data usage, connect to a Wi-Fi network whenever possible and set your online accounts and e-mails to sync less frequently.





Data usage measured by your phone may vary with your actual data usage.

1. On the Home screen or list menu, tap .
- Or, tap  > **System settings**.
2. Tap **Data usage**.
3. Turn on **Mobile data**, select **Set mobile data limit** to automatically disable your data connection when you reach the set limit.
4. Tap **Data usage cycle**, you can set a particular time interval to see how much data you have used.
5. Drag the red line marker to set your monthly data limit.



- You can check your data usage on notifications panel. On notifications panel, tap  to switch to quick settings list, and then tap **Data usage**.
- If you are connecting your phone to another portable Wi-Fi hotspot, tap  > **Mobile hotspots** to restrict background data from downloading that may incur extra data fees.

Check the data usage of apps

1. On the Home screen or list menu, tap .
- Or, tap  > **System settings**.
2. Tap **Data usage**.
3. On the mobile usage chart, drag the vertical line markers to see how much data you have used during a particular time interval.
4. Scroll down the screen to see a list of apps and their data usage info.
5. Tap an app to see more details.

Wi-Fi



Connect the device to a Wi-Fi network to use the Internet or share media files with other devices. To use Wi-Fi, you need access to a wireless point or hotspot.



The availability and strength of the Wi-Fi signal will vary depending on the environment, such as building structure or simply a wall between rooms. Wi-Fi signal has to pass through.

Turn on or off Wi-Fi

Follow these steps:

- On notifications panel, tap  to switch to quick settings lists, and then tap **WI-FI**.
- On the Home screen or list menu, tap , and then tap **Wi-Fi** to turn it on or off.

Connect to a wireless network

1. On the Home screen or list menu, tap , and then tap **Wi-Fi** to turn it on.
2. The Wi-Fi section will show the list of networks detected.
3. Tap the desired Wi-Fi network you want to connect to.
 - If you selected a secured network, you will be asked to enter the network key or password.



The next time your phone connects to a previously accessed secure wireless network, you will not be asked to enter the key or other security information again.

Erase a saved wireless network

Any network that has ever been used, including the current network, can be erased. Your phone will not automatically connect to it.

1. On the Home screen or list menu, tap , and then tap **Wi-Fi**.
2. Tap the wireless network you have previously been connected to.
3. Tap **Forget**.

Use your phone as a wireless router

Share your data connection with other devices by turning your phone into a wireless router.



- Make sure the data connection is turned on.
- You must have an approved data plan associated with your account from your mobile service provider to use this service.

1. On the Home screen or list menu, tap .
2. Tap **More...> Tethering & portable hotspot**.
3. In **Set up Wi-Fi hotspot**, enter a router name or use the default router name.
4. Choose the type of security and set the password (key) for your wireless router.
 - If you selected **None** in **Security**, you do not need to enter a password. The password is the key other people need to enter on their device so they can connect and use your phone as a wireless router.
5. Tap to turn on portable Wi-Fi hotspot.

Share your mobile data connection by USB tethering

You can use the data connection of your phone for your computer to connect to the Internet.



- Make sure your SIM card is inserted on your phone.
- You may need to have USB tethering added to your data plan, and it may incur additional cost. Contact your mobile service provider for details.



1. Connect your phone to the computer with the included USB cable.
2. On the Home screen or list menu, tap .
3. Make sure that data connection is turned on.
4. Tap **More...> Tethering & portable hotspot**.
5. Tap to turn on **USB tethering**.

VPN

You can connect and access resources inside a secured local network, such as your corporate network. Depending on the type of VPN you are using at work, you may be asked to enter your login credentials and install security certificates before you can connect to your company's local network. You can get this information from your network administrator. You must first establish a Wi-Fi or data connection before you can start a VPN connection.

Add a VPN connection

You must first set a lock screen PIN or password before you can use credential storage and set up the VPN.

1. On the Home screen or list menu, tap .
2. Tap **More... > VPN**.
3. Tap  to add VPN profile.
4. Enter the VPN settings and set them up according to the security details your network administrator gave you.
5. Tap **Save**.

Connect to a VPN

1. On the Home screen or list menu, tap .
2. Tap **More... > VPN**.
3. Tap the VPN that you want to connect to.
4. Enter your log in credentials, and then tap **Connect**. When you are connected, the VPN connected icon appears in the notification area of the status bar. You can then open the web browser to access resources such as your corporate network intranet.





Disconnect from a VPN

1. On the Home screen or list menu, tap .
2. Tap **More... > VPN**.
3. Tap the VPN connection to disconnect from it.



Web browse

You can use your phone to browse websites. Before browsing a website, please confirm that you have turn on data connection or Wi-Fi.

Browse a web page

1. On the Home screen or list menu, tap .
2. Enter your search keywords or a web page address.
3. While browsing a web page, you can:
 - Tap  to go to the previous web page.
 - Tap  to go to the next web page.
 - Tap  to open web page preview, and you can tap to close the web page.
 - Tap  to browse web pages from **Bookmarks**, **History** and **Saved pages**.

Add bookmarks

1. On the Home screen or list menu, tap .
2. Enter your search keywords or a web page address.
3. Browse a web page.
4. Tap  > **Save to bookmarks**.

Open a bookmark

1. While viewing a web page, tap .
2. Tap **Bookmarks**.
3. On the bookmarks tab, navigate to the bookmark you want to open, and then tap it.

Edit a bookmark

1. While viewing a web page, tap .
2. Tap **Bookmarks**.
3. On the bookmarks tab, tap and hold the web page you want to edit.
4. Tap **Edit bookmark** on the pop-up screen.
5. Enter your changes, and then tap **OK**.

View browsing history

1. While viewing a web page, tap .
2. Tap **History**.
3. On the history tab, tap a time period to see a list of web pages you have visited.

Download files

You can download files and apps directly from your favourite websites.



Files and apps downloaded from the web can be from unknown sources. To protect your phone and personal data, we strongly recommend that you download and open only the files you trust.

1. On the Home screen or list menu, tap .
2. Go to the website where you can download the file you want.
3. Follow the website's download instructions for apps.



Before you can install the downloaded app, you need to set your phone to allow installation of third-party apps in **System settings > Security > Unknown sources**.

View your downloads



1. On the Home screen, tap .
2. Tap the file to open it.

Browser settings

Customise the web browser to suit your browsing needs. Set display, privacy, and security options when using the web browser.

- From the browser screen, tap  > **Settings**.

Set homepage

1. On the Home screen or list menu, tap .
2. On the browser screen, tap  > **Settings**.
3. Tap **General > Set homepage**.
4. Select or insert the home page you want to use.

10. Bluetooth

10



Bluetooth

Your phone can connect to a compatible Bluetooth device for exchanging data. Bluetooth creates a direct wireless connection between two devices over short distances.



Do not use the Bluetooth feature for illegal purposes (for example, pirating copies of files or illegally tapping communications for commercial purposes).



Turn on or off Bluetooth

1. On the Home screen or list menu, tap .
- Or, tap  > **System settings**.
2. Tap to turn on or off **Bluetooth**.





You can tap to turn on or off Bluetooth on notifications panel. On notifications panel, tap  to switch to Quick Settings, and then tap **Bluetooth**.



Pair with a Bluetooth device

1. On the Home screen or list menu, tap .
- Or, tap  > **System settings**.
2. Tap to turn on or off **Bluetooth**.
3. A list of available Bluetooth devices will appear.
4. Select the device you wish to connect with.
5. Tap **Pair**. The pairing is made if your pairing request is accepted by the other device.

Unpair with a Bluetooth device

1. On the Home screen or list menu, tap .
- Or, tap  > **System settings**.
2. Tap **Bluetooth**.
3. Select the device you want to unpair and then tap .
4. Tap **Unpair**.



Receive data via Bluetooth

1. On the Home screen or list menu, tap .
- Or, tap  > **System settings**.
2. Tap to turn on or off **Bluetooth**.
3. Tap your phone model to make it visible to all nearby Bluetooth devices.
4. Accept the request and pair with the other Bluetooth device(s).
5. Slide to open notifications panel, tap **Accept**.



- If you do not use the Bluetooth feature for some time, you should deactivate it in order to conserve battery power.
- The files received via Bluetooth are stored in the Bluetooth folder.

Send data via Bluetooth

1. On the Home screen or list menu, tap .
- Or, tap  > **System settings**.
2. Tap to turn on or off **Bluetooth**.
3. Pair with a Bluetooth device.
4. Tap **ES File Explorer** on the Home screen or list menu.
5. Tap the file you want to share.
6. Tap  and select Bluetooth.
7. Select a device to start sending the file.

11. Apps

11

Play store



Use the Google Play Store to purchase and download applications and games that are able to run on your phone. Choose from a wide variety of free and paid apps ranging from productivity apps, entertainment, to games.

- On the Home screen or list menu, tap .



- A Google Wallet™ payment service is required to purchase a paid app. You will be asked to confirm the method of payment when you purchase an app.
- The name of the Play Store app may differ depending on your region.
- The ability to purchase apps varies by region.



Search and install an app

1. On the Home screen or list menu, tap .
2. Browse applications by category, or tap  to search with a keyword.
3. Select an application to view information.
4. To download it, tap **Install**.
 - If there is a charge for the application, tap the price, and follow the prompts to complete the purchase.



- When a new version is available for any installed application, an update icon will appear at the top of the screen to alert you. Open the notifications panel and tap the icon to update the application.
- To install applications that you downloaded from other sources, you need to set your phone to allow installation of third-party apps in **System settings > Security > Unknown sources**.

Uninstall an app in Play Store

1. On the Home screen or list menu, tap .
2. Tap  > **My Apps**.
3. Select an app you want to uninstall.
4. Tap **Uninstall**.

Manage your apps

Check the running apps

1. On the Home screen or list menu, tap  > **Apps**.
2. Go to the running tab, you can check all the apps running now.

Stop an app

1. On the Home screen or list menu, tap  > **Apps**.
2. Tap the app you want to stop.
3. Tap **Stop**.

Uninstall an app

1. On the Home screen or list menu, tap  > **Apps**.
2. Tap the app you want to uninstall.
3. Tap **Uninstall**.



- For different apps, the options maybe vary.
- You can not uninstall the essential apps and system app, such as Contacts, Settings and etc.

12. eReader Prestigio

12

With the eReader Prestigio, you can easily and quickly download and read e-books on your phone.

- On the Home screen or list menu, tap .

Your eReader at a glance

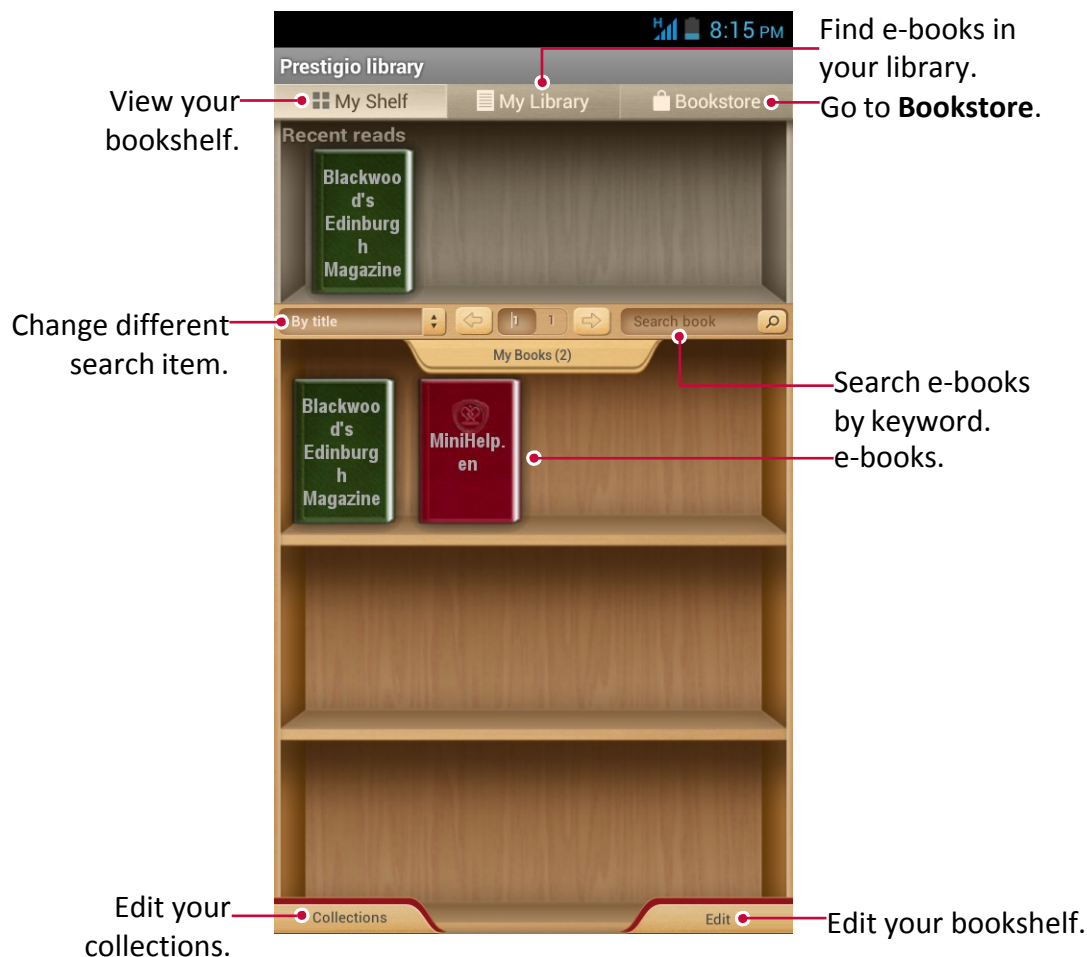



Download an e-book

You can download e-books via eReader Prestigio. Some e-books are free to download, and some e-books need a payment.





You will be asked to confirm the method of payment when you purchase a paid e-book.

1. On the Home screen or list menu, tap .
2. Tap **Bookstore**.
3. Search for your desired e-book.
4. Tap  to download the e-book.

Read an e-book



1. On the Home screen or list menu, tap .
2. Tap **My shelf** or **My library**.
3. Find your desired e-book.
4. Tap the e-book to read it.

Add a bookmark

1. While reading an e-book, tap .
2. Tap , and then tap **New bookmark**.
3. The selected page is added to bookmark.



Open a bookmark

You can continue reading your e-book from a page that you have added to bookmark.

1. While reading an e-book, tap .
2. Tap .
3. In **This book** or **All books**, tap your desired bookmark.



Search for a content

You can perform a search in the content of an e-book, for example, a word, a sentence or a paragraph, etc.

1. While reading an e-book, tap .
2. Tap .
3. Enter a word, a sentence or a paragraph, etc.
4. Tap **Go** in the virtual keyboard to search for the content page by page.



Zoom in and out

While reading an e-book, you can zoom in or out the screen to fit your reading.

1. While reading an e-book, tap .
2. Tap .
3. Tap **Zoom in** or **Zoom out**.

eReader settings

You can set up your eRead Prestigio while reading an e-book.

1. On the Home screen or list menu, tap .
2. Tap **My shelf** or **My library**.
3. Find your desired e-book.
4. Tap the e-book to read it.
5. While reading an e-book, tap .
6. Tap **Settings**.
7. Select your desired options.

13. Travel & maps



13

Use this application to pinpoint the location of your phone, search for places, or get directions.



Find a location

Turn on or off location service

In order to find your location on your phone, you need to enable location services.

1. On the Home screen or list menu, tap .
- Or, tap  > **System settings**.
2. Tap **Location access**.
3. Select or clear the location sources you want to turn on or off.

Find your location



1. On the Home screen or list menu, tap .
2. Tap  to find your location on the map.



- If you are in an area where there are a lot of surrounding buildings, Locations may have a hard time pinpointing your location.
- This application may not be available depending on the region or service provider.

Search for a place



You can search for a name of an establishment, street, or city. Suggested matches will be shown while you type.

1. On the Home screen or list menu, tap .
2. Tap .
3. Enter the place you want to search for.
4. Select the desired place in the result list.



Get directions

Get detailed directions to where you want to go.

Get directions from your location

1. On the Home screen or list menu, tap .
2. Tap  to get directions.
3. Choose how you want to get to your destination.
4. Enter the destination.
5. Select the desired place in the result list.
6. The map opens showing the route to your destination.

Get directions by setting a start and end location

1. On the Home screen or list menu, tap .
2. Tap  to get directions.
3. Choose how you want to get to your destination.
4. Enter your start point and end point.
5. The map opens showing the route to your destination.

Navigation

Use this application to search for a route to a destination while driving.



To use navigation, the GPS satellites option in **System settings > Location services** needs to be selected.



This application may not be available depending on the region or service provider.



Navigation maps, your current location, and other navigational data may differ from actual location information. You should always pay attention to road conditions, traffic, and any other factors that may affect your driving. Follow all safety warnings and regulations while driving.

Do the following to start navigation:

- In Locations, search for the place you want to go to, and then tap **Navigation**.
- On the Home screen or list menu, tap .

Use Google Maps

About Google Maps

Google Maps lets you track your current location and receive detailed directions to your destination. It also provides a search tool where you can locate places of interest or an address on a map, or view locations at street level.



- On the Home screen or list menu, tap .



- To find your location with Google Maps, you need to enable location services.
- The Google Maps app does not cover every country or city.

Use Google Maps

You can do the following:

- Tap  to search for a place.
- Tap  to get directions.
- Tap  to find your location on the map.

Get help

If you need help or have questions about Maps, tap  > **Help**.

Maps settings

You can set up the Google Maps, tap  > **Settings** while viewing the maps.

14. Files and storage

14

Your files



Use this application to access all kinds of files stored in your phone, including photos, videos, songs, and sound clips.

- On the Home screen or list menu, tap .

View your files

1. On the Home screen or list menu, tap .
2. Tap to choose a storage.
3. Select a folder to open it.

Search for a file

1. On the Home screen or list menu, tap .
2. Tap to choose a storage.
3. Tap , and enter a key-word.
4. Select the desired file or folder in the drop-down list.





Add a new folder

1. While viewing a folder or file, tap .
2. Enter a name for the new folder.
3. Tap **OK** to add the folder to the file list.

Manage my files

You can share, copy, move or delete a file in a folder.



While viewing a folder, tap and hold a file. You can make one of the following selections:

- Tap  to copy the file.
- Tap  to cut the file to clipboard.
- Tap  to delete the file.
- Tap  to rename the file.
- Tap  for more options.



Storage

If you connect a micro SD card to your phone, there are two storages: your phone and the micro SD card.



Check your storage usage

1. On the Home screen or list menu, tap .
 - Or, tap  > **System settings**.
2. Tap **Storage**.
3. You can check the total space of your phone's memory and SD card.

Set your preferred install location

1. On the Home screen or list menu, tap .
 - Or, tap  > **System settings**.
2. Tap **Storage**.
3. In **Default write disk** tab, tap to choose your preferred install location.

Erase SD card

1. On the Home screen or list menu, tap .
- Or, tap  > **System settings**.
2. Tap **Storage**.
3. Select **Erase SD card**.



Formatting a memory card permanently deletes all data from it.



The actual available capacity of the internal memory is less than the specified capacity because the operating system and default applications occupy part of the memory.

15. Utilities

15



Clock

Use the clock app to set alarms, check the time of any location in the world, measure the duration of an event, or set a timer.

- On the Home screen or list menu, tap .

World clock



You can add a city to the world clock screen.

1. On the Home screen or list menu, tap .
2. Tap .
3. Scroll through the list and tap the city that you want to add.

Alarm

You can set up one or more alarms.

Set an alarm



1. On the clock screen, tap .
2. Tap  to add a new alarm.
3. Use the virtual digit keyboard to set the alarm time.
4. Tap **OK**.
5. If you want the alarm for multiple days, tap **Repeat**.

Turn off an alarm



1. On the clock screen, tap .
2. Select the alarm you want to turn off.
3. Drag the check button to Off.

Stop an alarm

When the alarm rings,

- Slide to : The alarm stops.
- Slide to : The alarm will sound again after a specific length of time.



Delete an alarm

1. On the clock screen, tap .
2. Tap and hold the alarm you want to delete.
3. Tap .

Timer

1. On the clock screen, tap .
2. Set the duration, and then tap **Start**.

Stopwatch



- On the clock screen, tap .
- Tap **Start** to time an event.
- Tap  to record lap times.
- Tap  to clear lap time records.

Calendar



You can create events and make plans on your calendar.

- On the Home screen or list menu, tap .

View your calendar

On the Home screen or list menu, tap  to check the calendar. Tap  to change your calendar to day, week, month or agenda view.



Create an event

1. Go to , select a date.
2. Tap  > **New event**.
3. Edit reminder settings.
4. Tap **Done** to save the event.

Manage your events

Edit an event



You can only edit events you have created.

1. While viewing your calendar, tap  to change it to agenda view.
2. Tap the event you want to edit, and then tap .
3. Make changes to the event.
4. Tap **Done**.



If you are editing an event that repeats, you will be asked whether you want to edit just that occurrence or all occurrences of that event.



Delete an event

1. While viewing the calendar, tap  to change your calendar to agenda view.
2. Select the event you want to delete, and then tap .





If the event repeats, you will be asked whether you want to delete just that occurrence or all occurrences from Calendar.

Clear all events

- Go to , and then tap  > **Clear events**.

Share an event



You can share a calendar event as a vCalendar via Bluetooth or as a file attachment via an e-mail or a message.

1. While viewing the calendar, tap  to change your calendar to Agenda view.
2. Select the event you want to share, and then tap .
3. Choose how you want to send the event.

Calculator

This app can perform both simple and complex calculations.

On the Home screen or list menu, tap .



- Swipe to display the scientific calculator. Or, tap  > **Advanced panel**.
- To clear history, tap  > **Clear history**.

ToDo list

Use the ToDo app, you can organise and track ToDo and task lists.

- On the Home screen or list menu, tap .

Create your to-do list

1. On the Home screen or list menu, tap .
2. Tap .
3. Edit the title and details, and then set the expire date.
4. Tap **Done** to save the task.



Manage your to-do list

Edit a task



You can only edit tasks you have created.

1. On the Home screen or list menu, tap .
2. Tap the event you want to edit.
3. Make your changes to the task.
4. Tap **Done**.

Mark the task as done or undone

- Select the task on the **TODO** category, tap  to mark the task as done.
- Select the task on the **DONE** category, tap  to mark the task as undone.

Delete a task

1. On the Home screen or list menu, tap .
2. Tap the task you want to delete, and then tap .

Google search

Use this application to search not only the Internet, but also apps and contents on your phone.

- On the Home screen or list menu, tap .



Some apps, such as Contacts or E-mails, have their own search function, which you can use to search only those apps.

Search on the web or your phone



1. Tap the search field, and then enter a keyword.
2. Select one of the suggested keywords that appear.



If no results are returned from the apps, the web browser will appear, displaying the search results.

Search with your voice

Use Google Voice Search to find information on the web just by speaking to your phone.

1. On the Home screen or list menu, tap 
 - If the Google search bar is available on the Home screen, you can also tap .
2. Speak a keyword or phrase when **Speak now** appears on the screen.
3. Select one of the suggested keywords that appear.
4. If what you are searching for is in the list, tap the item to open it in its compatible app.

Otherwise, tap **Retry** to search again.



This application may not be available depending on the region or service provider.

Set search options

1. On the Home screen or list menu, tap .
2. Tap > **Settings** to set the following options:
 - **Voice:** Set the Google Voice Search language, speech output, and more.
 - **Phone search:** Select the apps on your phone that you want to include in your search.
 - **Privacy & accounts:** Manage your location history, enable recent web searches to show, or clear your search history.



Google Now

Launch Google search to view Google Now cards that show the current weather, public transit info, your next appointment, and more when you are most likely to need it. Join Google Now when opening Google search for the first time. To change Google Now settings, tap > **Settings** > **Google Now**.

16. Set up your phone

16

Use this app to control and customise your phone's settings .

- On the Home screen or list menu, tap  . Or, tap  > **System settings**.

Wireless & Networks

SIM management

- Check your SIM card information.
- Set the SIM card for data connection.



The device supports two SIM cards for voice calls and data connection. During a voice call or data transfer via one SIM card, the other SIM card becomes inactive (not registered with your mobile network operator). This means that you cannot receive incoming calls or use data connection via the inactive SIM card. When the call or data transfer ends, both SIM cards will become active and show on the list of registered networks.

Wi-Fi

Activate the Wi-Fi feature to connect to a Wi-Fi network and access the Internet or other network devices.

Bluetooth

Activate the Bluetooth feature to exchange information over short distances.

Data usage

Keep track of your data usage amount, and customise the setting for a limitation.

More...

Set up the following items.

• Airplane mode

Activate airplane mode to disable all wireless functions on your device. You can use only nonnetwork features.

Airplane mode disables the wireless features in order to reduce potential interference with aircraft operations and other electrical equipment.

• VPN

Set up and manage virtual private networks (VPNs).

• Tethering & portable hotspot

- Set to use your device as a wireless modem by making a USB connection with a computer.
- Set to use your device as a wireless access point for other devices.
- Activate the Bluetooth tethering feature to share your mobile network with computers via Bluetooth.

• Mobile networks



- Data connection: Use to allow packet switching data networks for network services.
- 3G service: Enable the 3G service. Contact your mobile operator for details.
- Access Point Names: Set up access point names (APNs).
- Network operators: Search for available networks and select a network for roaming.

- **USB internet**

Turn on to share the Windows PC internet via USB cable..

Device

Audio profiles

- Tap  to edit profiles. Or, tap  to add customised profiles.
 - Select the profiles for your phone.
 - Set the volume, type of ringtone and notification.

Display

Change the settings to control the display and backlight on your device.

Single hand

Change the panel of Calculator and Dial-pad when you are using a single hand.

Gesture

Do a gesture on the panel to launch an application.

Storage

View memory information for your device and memory card. You can also format the memory card.



Formatting a memory card permanently deletes all data from it.



The actual available capacity of the internal memory is less than the specified capacity because the operating system and default applications occupy part of the memory.

Battery

View the amount of battery power consumed by your device.

Apps

Manage running applications, move applications to or from the storage card, and install or uninstall programs.

Personal

Location access

Select the sources to use when determining your location.

- Access to my location: Set to use Wi-Fi and/or mobile networks for finding the current location.
- GPS satellites: Set to use the GPS satellite for finding the current location.
- Wi-Fi & mobile network location: Let apps use Google's location service to estimate your location faster.

Security

Set a screen lock or manage the credential storage.

Language & input

Set the operating system language and region. You can also set on-screen keyboard options.

Backup & reset

Change the settings for managing settings and data.

- Back up my data: Set to back up settings and application data to the Google server.
- Backup account: Set up or edit your Google backup account.
- Automatic restore: Set to restore settings and application data when the applications are reinstalled on the device.
- Factory data reset: Reset settings to the factory default values and delete all data.

Accounts

Add and manage your e-mail, Google, Face-book and Twitter accounts.

System

Date & time

Access and alter the following settings to control how the device displays the time and date.

- Automatic date & time: Automatically update the time and date when moving across time zones.
- Automatic time zone: Set to receive time zone information from the network when you move across time zones.
- Set date: Set your local date manually.
- Set time: Set your local time manually.
- Select time zone: Set your local time zone.
- Use 24-hour format: Display time in 24-hour format.
- Choose date format: Select a date format.

Schedule power on & off

Set the time to power on/off automatically.

Accessibility

Use these settings when you have downloaded and installed an accessibility tool, such as a screen reader that provides voice feedback. You can turn accessibility functions or services on or off.

About phone

Access device information and update device software. View different information about the phone, such as the battery, legal information, model number, software version, baseband version and build number.

17. Specifications

17

Item	Specification
Processor	High Performance dual-core 1.2GHz
Memory	RAM 512MB + ROM 4GB, Micro SD slot supports up to 32 GB
OS	Android 4.2
Display	5" FWVGA (480*854), capacitive touch
Camera	Front 0.3MP, rear 5MP AF
Band	UMTS: 900/2100MHz; GSM: 850/900/1800/1900MHz
Interfaces	Micro USB 2.0, micro SD (micro SDHC compatible)
Communications	WiFi (802.11 b/g/n), 3G, Bluetooth 3.0
Battery	3000mAh
Dimensions	150*76*9.9mm (H*W*D)
Weight	190 g

18. Specific Absorption Rate Information



International standards

THIS MOBILE PHONE MEETS THE INTERNATIONAL RECOMMENDATIONS FOR EXPOSURE TO RADIO WAVES.

Your mobile phone is a radio transmitter and receiver. It is designed and manufactured not to exceed the limits for exposure to radio frequency (RF) energy defined by the international standards. These recommendations have been established by the International Commission on Non-Ionizing Radiation Protection (ICNIRP) and, the Institute of Electrical and Electronics Engineers (IEEE) that forecast a substantial safety margin for assuring the protection of all persons, regardless of age and health. The exposure recommendations for mobile phones use a measurement unit known as the Specific Absorption Rate (SAR). The SAR limit recommended by the ICNIRP for the mobile phones used by the general public is **2.0W/kg averaged over ten grams of tissue and, is 1.6W/kg averaged over one gram of tissue** by IEEE Std 1528 for the head. Tests for SAR have been conducted using recommended operating positions with the mobile phone transmitting at its highest certified power level in all tested frequency bands. Although the SAR is determined at the highest certified power level, the actual SAR levels of the mobile phone while operating are generally below the maximum SAR value. This is because the phone is designed to operate at multiple power levels so as to use only the power required to reach the network. In general, the closer you are to a base station antenna, the lower the power output. While there may be differences between the SAR levels of various phones and at various positions, they all meet the international protection standards for exposure to radio waves.

The highest SAR value for this PAP3501DUO model when tested for compliance against the standard was 1.891 W/kg (10g) for ICNIRP recommendation. For limiting the radio waves exposure, it is recommended to reduce the mobile phone call duration or to use a headset. The purpose of those precautions is to take the mobile phone away from the head and the body.

19. Troubleshooting

19

The phone does not switch on

Remove/reinstall the battery. Then charge the phone until the battery icon stops scrolling. Unplug the charger and try to switch the phone on.

The display shows BLOCKED when you switch on the phone

Somebody tried to use your phone but did not know the PIN code nor the unblocking code (PUK). Contact your service provider.

The display shows IMSI failure

This problem is related to your subscription. Contact your operator.

The network symbol is not displayed

The network connection is lost. Either you are in a radio shadow (in a tunnel or between tall buildings) or you are outside the network coverage area. Try from another place, try to reconnect to the network (especially when abroad), or contact your network operator for assistance/information.

The touch screen responds slowly or improperly

If your device has a touch screen and the touch screen is not responding properly, try the following:

- Remove any protective covers from the touch screen. Protective covers may prevent the device from recognizing your inputs and are not recommended for touch screen devices.
- Ensure that your hands are clean and dry when tapping the touch screen.
- Restart your device to clear any temporary software bugs.
- Ensure that your device software is upgraded to the latest version.
- If the touch screen is scratched or damaged, take it to your local dealer.

Your battery seems to over heat

You might be using a charger that was not intended for use with your phone. Make sure you always use the authentic accessory shipped with your phone.

Your phone does not display the phone numbers of incoming calls

This feature is network and subscription dependent. If the network does not send the caller's number, the phone will display Call 1 or Withheld instead. Contact your operator for detailed information on this subject.

You can not send text messages

Some networks do not allow message exchanges with other networks. First check that you have entered the number of your SMS centre, or contact your operator for detailed information on this subject.

You can not receive and/or store JPEG pictures

A picture may not be accepted by your mobile phone if it is too large, if its name is too long, or if it does not have the correct file format.

You feel that you have missed some calls

Check your call divert options.

When charging, the battery icon shows no bar and the outline is flashing

Only charge the battery in an environment where the temperature does not go below 0°C (32°F) or above 50°C (113°F). In other cases please contact your phone supplier.

The display shows SIM failure

Check that the SIM card has been inserted correctly. If the problem persists, your SIM card may be damaged. Contact your operator.

Your phone does not work well in your car

A car contains many metallic parts that absorb electromagnetic waves which can affect the phone's performance. A car kit is available to provide you with an external antenna and enables you to make and receive phone calls without handling the handset.

Check with the local authorities whether or not you are allowed to use the phone while driving.

Your phone is not charging

If the battery is completely flat, it might take several minutes of precharge (up to 5 minutes in some cases) before the charging icon is displayed on the screen.

The picture captured with the phone camera is not clear

Make sure that the camera lens on both sides is clean.

When you turn on your device or while you are using the device, it prompts you to enter one of the following codes:

- Password: When the device lock feature is enabled, you must enter the password you set for the device.
- PIN: When using the device for the first time or when the PIN requirement is enabled, you must enter the PIN supplied with the SIM or USIM card. You can disable this feature with the Lock SIM card menu.
- PUK: Your SIM or USIM card is blocked, usually as a result of entering your PIN incorrectly several times. You must enter the PUK supplied by your service provider.
- PIN2: When you access a menu requiring the PIN2, you must enter the PIN2 supplied with the SIM or USIM card. For details, contact your service provider.

Your device freezes or has fatal errors

If your device freezes or hangs, you may need to close programs or reset the device to regain functionality. If your device is frozen and unresponsive, press and hold the power button for 8-10 seconds. The device reboots automatically.

If this does not solve the problem, perform a factory data reset. On the list menu, tap Settings > Back up & reset > Factory data reset > Reset device > Erase everything.

Others cannot hear you speaking on a call

- Ensure that you are not covering the built-in microphone.
- Ensure that the microphone is close to your mouth.
- If using a headset, ensure that it is properly connected.

Error messages appear when launching the FM radio

The FM radio application on your phone uses the headset cable as an antenna. Without a headset connected, the FM radio cannot receive radio stations. To use the FM radio, first ensure that the headset is properly connected. Next, scan for and save the available radio stations.

Another Bluetooth device is not located

- Ensure that the Bluetooth wireless feature is activated on your device.
- Ensure that the Bluetooth wireless feature is activated on the device you wish to connect to, if necessary.
- Ensure that your device and the other Bluetooth device are within the maximum Bluetooth range (10 m).

A connection is not established when you connect the device to a computer

- Ensure that the USB cable you are using is compatible with your device.
- Ensure that you have the proper drivers installed and updated on your computer.
- If you are a Windows XP user, ensure that you have Windows XP Service Pack 3 or higher installed on your computer.
- Ensure that you have Windows Media Player 10 or higher installed on your computer.