

acer
explore beyond limits™

Liquid | C1



© 2013 All Rights Reserved

Acer Liquid C1 Smartphone User's Manual

Model: I110

First issue: 03/2013

Acer Liquid C1 Smartphone

Model number: _____

Serial number: _____

Date of purchase: _____

Place of purchase: _____

Table of contents

Table of contents	3
Setting up	5
Unpacking your smartphone.....	5
Getting to know your smartphone.....	5
Installing a SIM or microSD card.....	6
To cancel the SIM lock, contact your network provider.....	6
Installing or removing the battery.....	6
Using your smartphone	8
Locking your smartphone.....	8
Using the touchscreen.....	9
The Home screen.....	11
Managing contacts	16
Managing your contacts.....	16
Making calls	18
Before making a call.....	18
Making a call.....	18
The voice call screen.....	19
Messaging	21
Creating a new message.....	21
MMS messages.....	22
Going online	24
Browsing the Internet.....	24
Setting up your Google email.....	24
Composing an email.....	24
Setting up Email.....	25
Maps, Navigation, Places and Latitude.....	26
AcerCloud setup	27
AcerCloud setup for Windows 7.....	27
Using the camera	30
Camera icons and indicators.....	30
Taking a photo.....	31
Taking a panoramic photo.....	31
Shooting a video.....	31
Supported formats.....	32
Viewing and sharing photos and videos.....	32
Advanced settings	33
Putting your smartphone in Airplane mode.....	33
Adjusting settings.....	33
Connecting to a PC.....	36
FM radio.....	37
Multimedia playback.....	37
Restoring to factory settings.....	39
Accessories and tips	41
Using the headset.....	41
Using a Bluetooth headset.....	41

Inserting a microSD Card	42
Appendix	43
FAQ and troubleshooting	43
Other sources of help	44
Warnings and precautions	44
Emergency calls	47
Taking care of your smartphone	47
Specifications	48
Safety	50
End User License Agreement.....	56

Setting up

Unpacking your smartphone

Your new smartphone comes packed in a protective box. Carefully unpack the box and remove the contents. If any of the following items is missing or damaged, contact your dealer immediately:

- Acer Liquid C1 Smartphone
- Battery
- Quick Guide
- USB cable
- AC adapter
- Headset

Getting to know your smartphone

Views

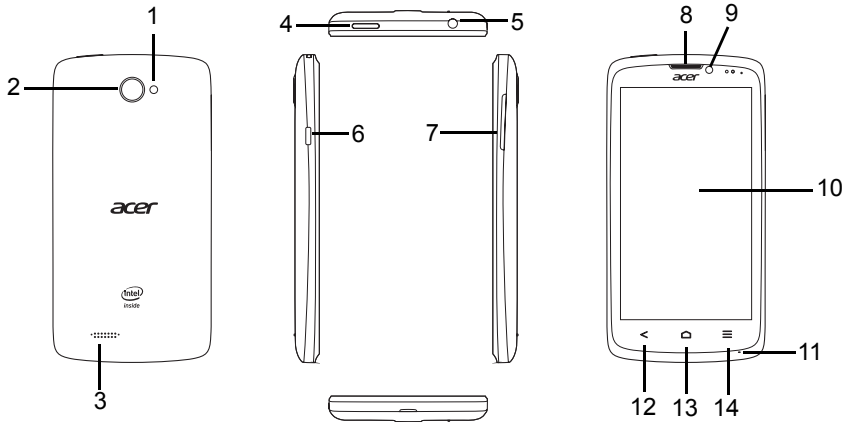

No.	Item	Description
1	Flash	LED flash for camera.
2	Camera	A 8-megapixel camera for taking high-resolution images.
3	Handsfree speaker	Emits audio from your smartphone; suitable for handsfree use.
4	Power button	Press to turn the screen on/off or enter sleep mode; press and hold to turn the smartphone on or off.
5	3.5 mm headphone jack	Connect to stereo headphones.
6	Micro USB connector	Connect to a USB cable/charger.
7	Volume up/down buttons	Increase or decrease the phone volume.

No.	Item	Description
8	Phone speaker	Emits audio from your smartphone; suitable for holding to your ear.
9	Front camera	A front camera for video calls.
10	Touchscreen	4.3-inch, 960 x 540 pixel capacitive touchscreen to display data, phone content and enter information.
11	Microphone	Internal microphone.
12	Back button	Go back one menu step; close the keyboard.
13	Home button	Return to the Home screen; press and hold to view recently-used applications, tap an icon to open the associated program.
14	Menu button	Open the option menu; press and hold to display the keyboard.

Installing a SIM or microSD card

To take full advantage of your smartphone's telephony capabilities, you must install a SIM card. The SIM card holder is located at the top of the battery bay.

Additionally, you may wish to increase your smartphone's storage by inserting a microSD card into the slot provided. This is next to the SIM card slot.

1. Turn off the phone by pressing and holding the power button.
2. Open the cover and remove the battery as described in **"Removing the battery"** on page 7.
3. Insert the SIM or microSD card as shown.
4. Replace the battery and battery cover.

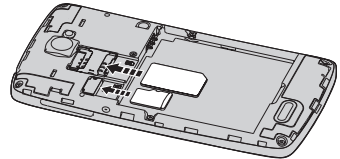

Note: Ensure that the microSD card is inserted all the way into the card slot.

SIM card lock

Your smartphone may come with a SIM card lock, i.e., you will only be able to use the SIM card provided by your network operator.

To cancel the SIM lock, contact your network provider.

Installing or removing the battery

Your smartphone uses a replaceable battery to provide power. It is packed separately from your smartphone and needs to be inserted and charged before you can use the smartphone.

Installing the battery

Insert your fingernail into the cutout between the battery cover and the phone. Unclip the cover and lift off the battery cover.

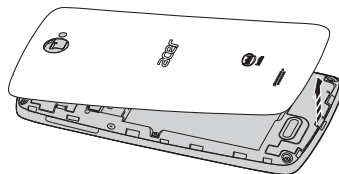

Place the battery into the battery compartment, lining up the battery connectors with those at the top of the compartment.

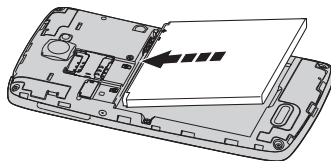

Align the tabs on the cover into the slots on the phone. Gently press the cover until it snaps in place.

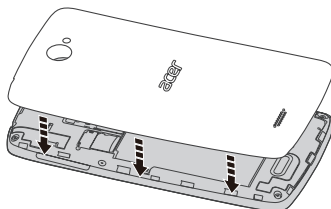

CAUTION: RISK OF EXPLOSION IF BATTERY IS REPLACED BY AN INCORRECT TYPE.

DISPOSE OF USED BATTERIES ACCORDING TO THE INSTRUCTIONS.

Charging the battery

For initial use, you need to charge your smartphone for eight hours. After that you can recharge the battery as needed.

Connect the AC adapter cord to the micro USB connector on your smartphone.

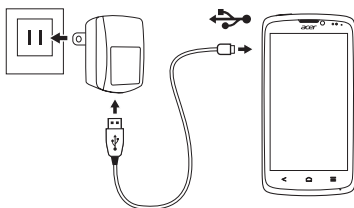

Removing the battery

Open the battery compartment as shown in "**Installing the battery**" on page 7. Lift the battery out of the compartment by lifting at the top of the battery on either side of the camera.

Replace the battery cover as described above.

Using your smartphone

Turning on for the first time

To turn on your smartphone for the first time, press and hold the power button until the screen turns on. You will then be asked to configure some settings before you can use your smartphone.

Follow the onscreen instructions to complete setup.

Sign in to or create a Google account

If you have Internet access, your smartphone allows you to synchronize information with a Google account.

During the start-up process, you may create or sign in to your account, which will be used to synchronize your contact list, email, calendar and other information. If you do not yet have Internet access, or do not want to use this feature, then tap **Skip**.

Creating multiple Google accounts

You can create and easily access multiple Google accounts. Open the **Application** menu and then tap **Settings > Accounts & sync > Add account**.

Entering your PIN

When you install a SIM card for the first time, you may need to enter a PIN using the onscreen number pad.



.....
Important: Depending on your settings, you may be required to enter your PIN each time you switch on the phone function.
.....

Activating a new SIM card

If you are using your SIM card for the first time, it may require activation. Contact your network operator for details on how to do this.

Locking your smartphone

If you will not use your smartphone for a while, briefly press the power button to lock access. This saves power and ensures your smartphone does not unintentionally use any services. Your smartphone will lock automatically if it is not used for one minute.

Waking your smartphone

If the screen is off and the smartphone does not react to any taps on the screen or front panel button, then it has been locked and is in sleep mode.

Press the power button to wake your smartphone. Unlock your smartphone by dragging the lock icon to the right side of the screen towards the unlock icon.

For additional security, you may set an unlock pattern, a set of dots that must be tapped in the correct order to access the phone. Open the **Application** menu and then tap **Settings** > **Security** > **Screen lock**.

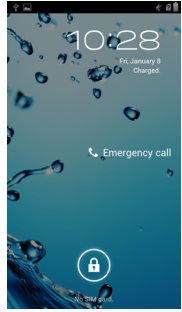

Note: If you forget your unlock pattern, please refer to "**Unlock pattern**" on page 43.

Using the touchscreen

Your smartphone uses a touchscreen for selecting items and entering information. Use your finger to tap the screen.

Tap: Touch the screen once to open items and select options.

Drag: Hold your finger on the screen and drag across the screen to select text and images.

Tap and hold: Tap and hold an item to see a list of actions available for that item. On the pop-up menu that appears, tap the action you want to perform.

Scroll: To scroll up or down the screen, simply drag your finger up or down the screen in the direction that you want to scroll.

Android keyboard

This is a standard onscreen QWERTY keyboard that allows you to enter text. Tap and hold a key with numbers at the top to select alternative characters, such as letters with accents.

Tap the **?123** button to see numbers and special characters, and then tap the **ALT** key to see even more.

You can switch between multiple input languages by swiping across the space bar. The keyboard layout will change accordingly. To select your preferred languages, open the **Application** menu and then tap **Settings** > **Language & input** > **Android keyboard** > **Input languages**.

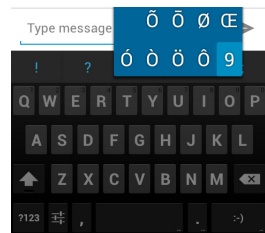

Text assistance

The Android keyboard has various features that assist you to enter correct text. In the **Application** menu, tap **Settings** > **Language & input** and then tap the settings

icon on the right side of **Android keyboard**. From here you can enable or disable the several keyboard related settings, including the following:

Function	Description
Auto correction	Spacebar and punctuation automatically correct mistyped words.
Show correction suggestions	Shows suggested words while you are typing.

Changing the text input method

To change the input method, in the **Application** menu tap **Settings > Language & input > Default** and then select your preferred input method.

Predictive text

Both XT9 Text Input and Android keyboard provide predictive text input. As you tap the letters of a word, a selection of words are displayed above the keyboard that continue the sequence of letters tapped, or are a close match allowing for errors. The word list changes after every key press. If the word you need is displayed, you can tap on it to insert it into your text.

Swype

Swype is a fast way to enter text. It allows you to type with one continuous motion across the screen keyboard; you create a word by drawing through letters.

Put your finger on the first letter of the word and draw a path from letter to letter, lifting up only after the last letter. Swype will insert spaces where necessary.

Swype will usually add a double letter in a word when needed, but you can help Swype recognize you want a double letter by scribbling slightly or making a loop on the letter. For example, to get the "ll" in "hello", scribble (or make a loop) on the "l" key.

When there are multiple suggestions for the word you want to enter, Swype displays a Word Choice List. To accept the default word in the Word Choice List, just keep Swyping. Otherwise, scroll through the list by dragging your finger, and tap the word you want.

Tap the Swype key to turn the ability to draw words on or off. Press and hold the Swype key to access settings, help, and to change input methods.

Tap the **+! =** button to see numbers and special characters; tap the page (shift) key to see even more.

Additional keys vary depending on the type of text you enter, e.g. a key to add a smiley is available when typing a text message. Like other keys, tap and hold for additional options.

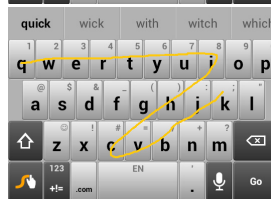

Text assistance

The Swype keyboard has various features that assist you to enter correct text. In the **Application** menu, tap **Settings > Language & input > Swype**. You can also tap and hold the Swype key . From here you can enable or disable the following:

Function	Description
How to Swype	Learn how to use the Swype keyboard.
Preferences	Change your text input preferences.
Language Options	Set the language used by the keyboard.
Swype Connect	Add contact names and words used in posts to your personal dictionary. Change data settings.
Personal dictionary	Check words added you your personal dictionary.
Updates	Check for application and dictionary updates.

The Home screen

After rebooting, your smartphone will display the home screen. This screen gives you quick, icon-based access to many of the frequently used features of your smartphone.

At the bottom of the screen is the **application dock** which displays default applications. Tap an icon to open the application. Tap the Application icon in the middle of the application dock to view your applications. To change applications, see "**Changing application dock icons**" on page 12.

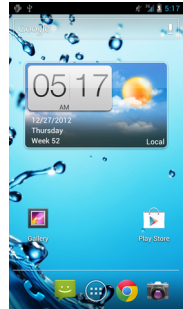

The extended Home screen

The Home screen extends to either side of the screen, giving you more room to add icons, widgets or features. To view the extended screen, slide your finger to the left or right.

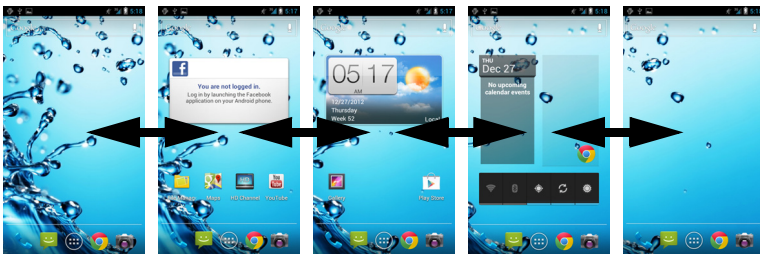

Adding or removing icons

You can set icons for installed applications on the Home screen. Tap and hold an icon in the Application menu to copy it to the Home screen. To remove an icon from

the Home screen, tap and drag the icon from the Home screen to **Remove** that appears at the top of the screen.

Adding or removing widgets

To add widgets, press the **Application** icon and then tap **WIDGETS**.

Resizing widgets

Some widgets can be resized. As soon as you place a widget on the Home screen, you can resize it by dragging the corners.

To resize a widget that is already on the Home screen, tap and hold the widget. Once the **Remove** icon appears, release the widget. If the widget is resizable, you will be able to drag the sides of the widget to resize it.



Adding or removing folders

You can also add folders to your Home screen. To create a new folder drag and drop an application icon onto another application icon in the Home screen. This will create an **Unnamed Folder**. Tap the folder icon and then tap the name of the folder to rename it.

To delete an application shortcut from a folder, tap on the folder icon to display the applications inside and then tap and hold the application icon that you want to remove. Drag and drop the icon on **Remove** that will appear at the top of the screen.

To delete a folder, tap and hold on the folder and then drag and drop the folder on **Remove** that will appear at the top of the screen.

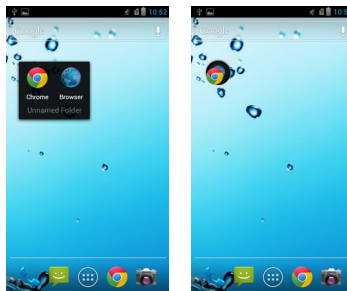

Changing application dock icons

You can set icons for installed applications in the application dock. Open the applications menu and find the application you want to add. Tap and hold the icon, then drag it to a position in the dock, it will be added in place of the existing application.

To remove an icon from the dock, open the applications menu, then tap and hold an icon to select it. Either drag the icon to a different page in the applications menu, or to the trash icon that appears at the bottom left corner of the screen.

Changing the wallpaper

On the Home screen, tap the **Menu** button and then tap **Wallpaper** to change the current wallpaper. You can choose from images stored in the Gallery, or Live Wallpapers featuring animated or interactive backgrounds, or standard wallpapers.

Multitasking

You can have multiple applications open at the same time. To open a new application, press the **Home** button to return to the Home screen, then start the new application.

To view your recently used applications, press and hold the **Home** button. Then tap an icon to go to the application.

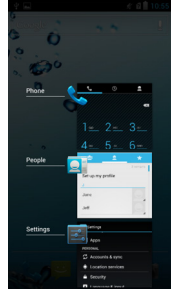

Tip: To prolong battery life, it is better to close an application when you've finished using it. Do this by either pressing the **Back** key or the **Menu** button and selecting **Exit** (if available).

Recent apps

To access recently opened apps while working on another process, press and hold the **Home** button.

The Application menu

To access the Application menu, on the Home screen tap  in the center of the dock.

Applications are displayed in alphabetical order. If more applications are available, an outline of the second page will be shown on the side of the screen. Swipe the outline towards the center of the screen to switch pages.

Otherwise swipe to the left to see more Applications. When you are on the last page of applications, swipe to the left to see widgets available on your tablet.

Tap the **Shop** icon to open the Google Play.

To quickly jump to applications or widgets, tap the **APPS** or **WIDGETS** tabs at the top of the Application menu.

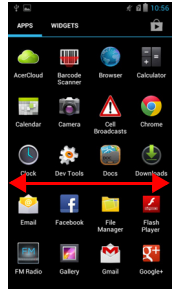

Note: All images are for reference only. The applications installed on your device can be different from the applications shown in illustrations.

Notification area

The Notification area is at the top of the screen.



This area contains a variety of icons to inform you of your phone's status. The left side of the Notification area displays event icons that indicate a new event (such as a new message). The icons on the right side indicate signal strength, connection, battery status and the time.

Drag the **Notification area** down the screen to view more information about new events.

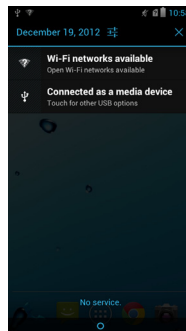

Connection icons



Note: Some connection icons appear blue if you have an active Google account.



























Icon	Description	Icon	Description
	Connected to GPRS mobile network		Roaming
	Connected to EDGE mobile network		Cellular signal strength
	Connected to 3G mobile network		Mobile data transferring
	Connected to HSDPA network		Connected to a wireless network
	Bluetooth is on		No signal
	Bluetooth connected		Airplane mode (Wireless connectivity disconnected. Please disable airplane mode before trying to make a call.)
	USB and wireless tethering are activated		USB tethering is activated
	Wireless tethering is activated		

Battery icons

Icon	Description	Icon	Description
	Battery is low		Battery is partially drained
	Battery is charging		Battery is full

Notification icons

Icon	Description	Icon	Description
	Alarm is set		SIM card is invalid or not installed

Icon	Description	Icon	Description
	Speakerphone is on		Vibrate mode
	New Gmail message		Ringer is silenced
	New/unread SMS/MMS		Phone microphone is off
	Problem with sending SMS/MMS		Application update available
	New Google Talk message		System update available
	New voicemail		Missed call
	Upcoming event		Song is playing
	Syncing data		More notifications
	Warning, pull down notification area for more information		GPS is on
	SD card or USB storage is full		Receiving location data from GPS
	An open wireless network is available		Uploading data
	Phone is connected to PC via USB		Downloading data
	Carrier data use threshold exceeded		Download finished
	Connected to or disconnected from virtual private network (VPN)		



Managing contacts

Managing your contacts

Your smartphone features an address book that allows you to save contacts to either the internal memory or onto your SIM card.

Open the **People** application from the APPS menu or tap the **People** tab from the Dialer to view your contacts.

If you don't have any contacts stored on your phone, you can import your Google account contacts, add a new contact or import contacts from your SIM or SD card. Open the **People** application

from the APPS menu and then tap  to add a contact,  to search for a contact, or tap the **Menu** button to open the menu.

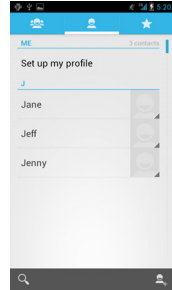

Adding a contact

Tap  to add a new contact. You may also scan a person's profile barcode to add the person to your contact list or group.

To create a contact, you will be asked to enter the contact's:

- Name
- Organization
- Title
- Phone numbers
- Email addresses
- Postal addresses

Tap **Add another field** to add things such as:

- IM addresses.
- Add any personal notes about the contact.
- Phonetic name
- Link a website

To assign an image to your contact, tap the silhouette and select whether to take a photo or select an image from your smartphone's picture gallery.

When done, click **Done** at the top of the screen.

Tapping on the contacts name will bring up their profile. Tap the **Menu** button while viewing a contact's profile to:

- Edit the contact.
- Share the contact.
- Delete the contact.
- Set a ringtone for the contact.
- Divert calls from the contact to voicemail.

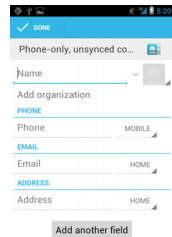



.....
Tip: You may also create a contact from an already dialed or received number, see
"Saving a dialed number to contacts" on page 19.
.....

Making calls

This chapter shows you how to make phone calls, and the various options available to you during your call.

Before making a call

Check that the phone function is on before you make a call. You can confirm the phone status from the icon on the right-hand side of the Notification area.



.....
Note: Status and notification icon colors may vary.
.....

Icon	Description
	Connected to the network: You may make a call.
	Airplane mode: Wireless connectivity disconnected (Wi-Fi, Bluetooth, 2G and 3G). Please disable airplane mode before trying to make a call.

Making a call



.....
Note: The phone function needs to be enabled before the call can be connected.
.....

1. From the Home screen tap **Phone** to open the onscreen number pad.
2. Enter the number you wish to dial.
3. Tap to make the call.
4. To end the call, tap .

If the contact you need is displayed, simply tap the contact name to make a call.

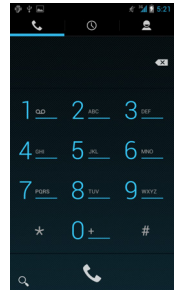

Dialing a number from Call Log

Your call history can be viewed by tapping the **Call Log** tab. It displays recent received, dialed, and missed calls.

Tap the phone icon to redial. To view details of the call, tap the number or contact's name. While viewing the details of a call, tap the **Menu** button for other options:

Remove from call log; Edit number before call.

Viewing missed calls

Missed calls will be displayed by the call indicator in the Notification area with

the icon.

1. Open the notification list by tapping the Notification area to display the details of the missed calls.

2. Select the call from the list and tap view the call in your Call Log.

You can save phone numbers to your contacts list from the Call Log. Please refer to **"Adding a contact" on page 16** for further details.

Saving a dialed number to contacts

You can save a number you have dialed to your contacts for future use.

1. Tap the **Call log** tab in the phone application to view your recently dialed numbers.
2. Tap on the number, and then tap  to add to your contacts.

Making a call to one of your contacts

Calling a contact from the People tab

1. Tap the **People** tab in the onscreen number pad to view your contacts.
2. Tap on a contact to call them.

Calling a contact from the People application

1. Tap the **People** icon in the Home screen or in the Application menu to view your contacts.
2. Tap on a contact to open their profile.
3. Tap on the contact's phone number to call them.

Dialing an international number

When dialing international numbers, there is no need to enter the international direct dialing prefix ('00' etc.) before the country code. Simply tap and hold 0+ on the onscreen number pad until + appears onscreen.



.....
Warning: International call rates can vary greatly depending on the country you are calling and your network provider. We suggest you check all call rates with your network provider, to avoid excessive phone bills. If you are using your smartphone abroad, roaming charges will apply. Consult your network provider for roaming rates specific to the country you are visiting before you leave.
.....

Direct dial widget

You may add a direct dial widget for a contact on your Home screen. Open the **Application** menu, then tap the **WIDGETS** tab. Tap and hold **Direct dial** and you will be able to place the widget on your Home screen. Once placed, you will be able to select a contact to associate with that particular widget on your Home screen.

The voice call screen

Once you have dialed your number the voice call screen appears, which displays the number/contact you are talking to, the call duration and voice call options.

Answering or declining a call

When you have an incoming call, the number will be shown on the screen. To accept or decline the call, drag the phone icon to the appropriate icon.



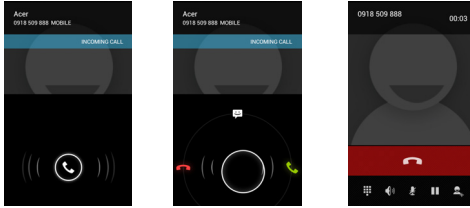

To decline the call with a text message, drag the phone icon up to the  icon and then select a message.



Ending a call

To end a call, tap  from the voice call screen.

Voice call options

Icon	Description
	Place the call on hold.
	Mute a call.
	Speakerphone.
	Access the keypad while a call is in progress.
	Add a second call.



Saving a dialed number to contacts

You can save a number you have dialed to your contacts for future use.

1. Select the number from the **Call log** tab, and tap **Add to contacts** .
2. Tap **Create new contact** and select how to complete the action. Please refer to **"Adding a contact" on page 16**.

Conference calls

If you have one call on hold and another on line, you can combine both calls to create a conference call.

After the first call is established, tap  to add a second call. Tap  to start the conference call.

Messaging

This chapter shows you how to set up and use the **Phone messages**, **Social messages** and **Social events** functions of your smartphone.

All SMS and MMS messages are accessed via **Messaging**. Messaging automatically arranges received and sent messages into threads.

To access Messaging tap **Messaging** on the Home screen.

Creating a new message

You can use your phone to compose Phone (SMS and MMS) messages.

Tap  to compose a new message.

Tap , or enter the recipient's phone number or name in the **To** field. Suggested contacts will be displayed in a drop-down list below the text field. To select a suggested contact, tap the contact's name.

Once you have entered the recipient, enter your message in the text box labeled **Type message**.

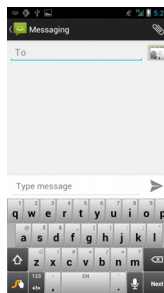

.....
Note: SMS messages may be up to 160 characters long. If your message is longer than 160 characters, it will be sent as multiple linked messages. Most phones will automatically join the linked messages to present the recipient with a single long message, however, some older phones do not have this ability.
.....

Tap the Menu button to see what options are available when creating a new message. The options change depending on the status of the message.

Option	Description
Add subject	Add a subject to the message.
Send	Send the message.
Insert smiley	Insert a smiley/emoticon into your message text.
Delete thread	Delete the message thread.
Discard	Discard the message.

Replying to a message

When a new text message arrives a message icon appears in the Notification area and the message icon on the top of the phone lights up.

Tap **Messaging** on the Home screen to view the message list or expand the Notification area to see a summary of the message. Tap the summary to open the message list.

To reply to an SMS or MMS message, open the message from the message list. Enter your text in the text box labeled **Type message**. Tap the Menu button to see available options.

Option	Description
Add subject	Add a subject to the message.
Send	Send the message.
Insert smiley	Insert a smiley/emoticon into your message text.
Delete thread	Delete the message thread.
Discard	Discard the message.

MMS messages

MMS messages are similar to text messages but also allow you to attach multimedia files such as pictures, audio or video clips. Each MMS message can be up to 300 kB in size.



Note: You need to set up an MMS profile before you can send MMS messages. Normally, your smartphone will set up the profile for you based on information retrieved from your provider.



Tip: Ask your network provider for the necessary information if you need to manually set up the MMS profile.

Receiving MMS messages

When a new MMS message arrives, a message icon appears at the top of the screen and a notification message is displayed.

1. Open Messaging to view a summary of the message.
2. Tap **Download** to download the message content.



Note: Downloads can take a long time, depending on your connection quality. If you reply or open another application, the download will be stopped.



Important: You may be charged to download message content, especially if you are roaming. Please contact your provider if you have any questions.

3. Tap the message to view the content.
4. To reply to the message, enter your text in the text box labeled **Type message** and tap the **Send** icon. Simple text replies will be sent as SMS messages. If you wish to attach a file, tap . You will be presented with a menu of options.
5. When you have finished composing the message, tap the **Menu** button and tap **Send**.

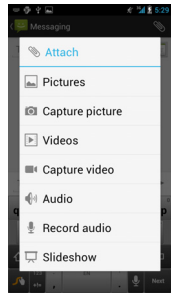

Going online

Browsing the Internet

In order to browse the Internet with your smartphone, you must be connected to a data or wireless network.

Using the browser

To start browsing, tap the **Chrome** icon on the Home screen, or open the Application menu and select **Chrome**. To open a new website, tap the address box at the top of the page. Enter the address using the keyboard and tap **Go**. You can zoom in or out of pages by pinching or reverse pinching.

To navigate forward and backward in your browser's history, view your bookmarks, adjust browser settings, and perform other tasks, tap the **Menu** button.



Chrome enables you to open multiple pages. Tap  at the top of any webpage to display all of your open tabs (tap again to close). Tap a tab from the list to open it. To open a new tab, tap **New tab**. The number in the icon represents the number of open tabs.

Voice search



.....
Note: Voice search is available only in some regions.
.....

With voice actions, you can send text messages, place calls, send emails, find directions of establishments, automatically call establishments, search the Internet and even send a note to yourself using your voice. Open Voice Search from the Applications menu, or tap  from the Home screen.

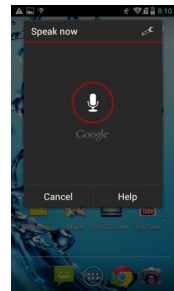



Setting up your Google email

1. Make sure your smartphone is connected to a data or Wi-Fi connection.
2. From the Applications menu tap **Gmail**.

If you did not enter your Gmail account address and password when you first started your phone, follow the on screen instructions.

Composing an email

1. Make sure your smartphone is connected to a data or Wi-Fi connection.
2. From the Applications menu tap **Gmail**.

3. Tap .
4. Enter the recipient's email address, the subject and message.
5. When you are finished composing your message, tap .

Setting up Email

Your smartphone enables you to access your email. Most popular ISPs can be set up in two steps. In the Applications menu tap **Email** to start setting up your email account.

If necessary, enter your email address and tap **Manual setup** to enter the parameters manually. Tap **Next** to finish the setup process.

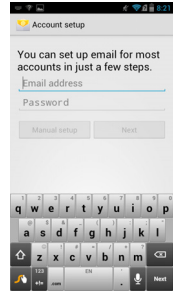

Google Play



.....
Note: Google Play may not be available in all countries and regions.



.....
Note: You must activate a Google account before using Google Play. The first time you access Google Play, you will need to read and accept the Terms of Service.

Tap **Play Store** from the Applications menu to open the Google Play. Here you can obtain a variety of add-on programs and applications to enhance the functionality of your smartphone.



.....
Note: The contents and design of Google Play varies by region. For example, in some regions, you can also browse for and purchase movies, books, magazines, or music. Updates may add new categories or change how to navigate Google Play at any time.

You can browse the store by category or tap the search icon to search for a specific application.

Once you have selected an application, tap the **Download** button to download and install the application. You will be told which services on your phone that the application has access to. Tap **OK** to proceed with the installation.

You may keep track of the download progress from the Notification Area.



.....
Important: Some applications may require payment before you can download them. You will need to have a Google Checkout account in order to pay for these applications, or a credit card number associated with your Google account.

Using downloaded applications

Once you've downloaded and installed an application, you may find it in the APPS or WIDGETS sections of the Application menu.

Certain applications provide both an App and widget, or only provide a widget (with no application icon). See “The Home screen” on page 11.

Uninstalling downloaded applications

Once you've downloaded and installed an application, you may uninstall the application by tapping **Settings** from the Applications menu. In the Settings menu select **Apps > Manage applications**. Tap the application you wish to uninstall, tap **Uninstall** and confirm the uninstall.



.....
Note: Deleting an app from the Home screen only deletes the shortcut.
.....

Maps, Navigation, Places and Latitude

Get easy-to-follow directions using Google Maps, view real-time traffic condition and navigate by using spoken, turn-by-turn driving instructions with Navigation, view where your friends are and places of interest and local businesses on Google Maps using Places and Latitude.



.....
Important: Maps does not have information about every location.
.....

Using the map

Tap the Maps icon in the applications menu. Drag the map with your finger to move the map around.

To zoom in or out:

1. Double tap a location on the map to zoom in on the location, and tap once to zoom out, or
2. Touch an area with two fingers at once and spread them apart to zoom in, and pinch them together to zoom out.



.....
Important: Not all zoom levels are available for all locations.
.....

AcerCloud setup

AcerCloud is a personal cloud service that allows you to access your files over the Internet, and make sure your most important files are always up to date. With your personal cloud all your devices (PC, tablet, phone) with AcerCloud installed can access files on your main Cloud PC. Open the **Application** menu and tap **AcerCloud**.

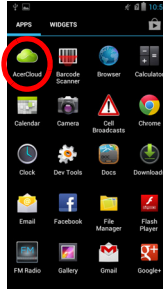

For more information please visit the AcerCloud website:

www.acer.com/acercloud



Note: To access files on other devices, your Cloud PC must be on and connected to the Internet. If your PC has Always Connect, your PC may be in Sleep mode, but must be connected to a power supply (not battery power).

AcerCloud setup for Windows 7

To install AcerCloud on a PC without AcerCloud, you can download the AcerCloud setup program from the AcerCloud website (<https://www.cloud.acer.com/ops/downloads>) and select AcerCloud Installer in the Windows part.



Windows



After download, double-click on the installer and follow the instructions to install AcerCloud.



AcerCloud is designed for Windows 7 and Windows 8. It is not compatible with older Windows Operation Systems or MAC OS X.

Install AcerCloud

Double-click on the **AcerCloud** icon, then double-click on **AcerCloudSetup**. Follow the instructions to install AcerCloud.

Sign in using your Acer ID

Start the **AcerCloud** program from the desktop or Start Menu.

If you already have an Acer ID, use your email address and password to sign in to your AcerCloud account.

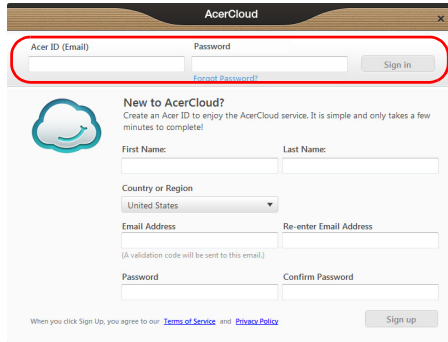

Create an AcerCloud ID

If you do not have an AcerCloud ID, you first need to sign up for an AcerCloud account, which you can do from your smartphone. Open the **Application** menu, tap **AcerCloud**, then tap **Sign up for an Acer ID**, and enter the requested information

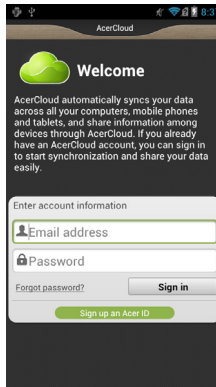

Make a note of the email address and password you used for your Acer Cloud ID. You must use this information to sign in to the AcerCloud service from each follow the instructions to register a new Acer ID.

After entering the information, tap **Next** to apply for an Acer ID. Check your email account for an Acer ID activation message and click on the link in the email to activate your Acer ID device.

AcerCloud options

When you install AcerCloud, you have several options. Select the options that are useful on your PC and click **Next** to complete the setup:

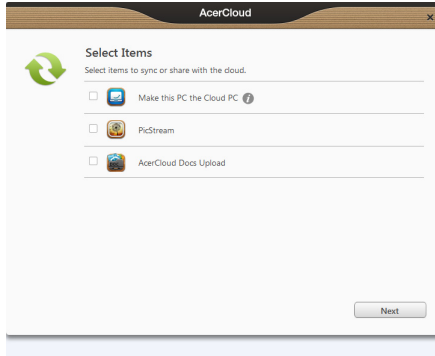

PicStream - Take holiday snapshots on your smartphone and share them with other smart devices. Photos will be backed up permanently on your Cloud PC (see below), and temporarily accessible for 30 days in your personal cloud and on other devices.

Make this PC the Cloud PC - You must define one (and only one) PC as your Cloud PC. Copies of all content added to your personal cloud (e.g. with PicStream) will be transferred to your Cloud PC, and content on this PC will be available to your other AcerCloud devices.



.....
Important: If you already have a Cloud PC, do NOT select this option.
Your Cloud PC must be connected to the Internet and have sufficient storage for all your media content.
.....

AcerCloud Docs Upload - When you update and save a document on your PC, the document will be put into the personal cloud and streamed to other devices. Documents will be temporarily accessible for 30 days in your personal cloud. You can download documents to other devices for long-term storage.



.....
Note: If AcerCloud Docs Upload is not available, click on the AcerCloud icon in the notification area (the bottom-right corner of the Windows desktop) and select **Check for updates** to install AcerCloud Docs.
.....



.....
Note: You can access and change these AcerCloud settings from the AcerCloud icon in the Notification area (the bottom-right corner of the Windows desktop). Click on the AcerCloud icon, then select **Open AcerCloud** to see the settings window.
.....

Using the camera

Your smartphone features a 8-megapixel digital camera mounted on the rear, with a VGA front-facing camera function. This section will take you through all the steps in taking photos and videos with your smartphone.





To activate the camera, tap **Camera** on the Home screen, or open the Applications tab and tap **Camera**.

Camera icons and indicators

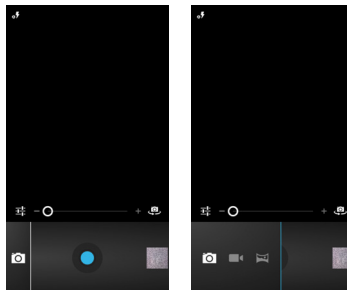
In the camera window, the three icons on the left can be tapped to expand. They allow you to switch between the camera, camcorder, and panoramic camera. Use the zoom slider at the bottom of the screen to adjust the zoom.





Tap  to take a picture. Tap the thumbnail in the bottom-right corner to open the gallery.



Icon	Description
	Activates the camera.
	Activates the video recorder.
	Activates the panoramic camera.
	Switches between the front-facing and rear camera.

Camera settings



To adjust the settings, tap  while the camera is active. The menu options are:

Icon	Description
	Display additional camera settings.
	Set white balance.
	Set the flash on, off, or auto.
	Set the exposure.
	Set the scene mode.

Icon	Description
	Set the color effect.

Camcorder settings

To adjust the settings, tap  while the camcorder is active. The menu options are:

Icon	Description
	Display additional camcorder settings.
	Set white balance.
	Set the flash on or off.
1080p 720p 480p	Set the video quality.

Taking a photo

1. Frame your subject and steady your smartphone.
2. Zoom in or out as needed.
3. Tap the blue button to take the photo.

Taking a panoramic photo

Panoramic mode allows you to take a series of five photos that the camera application will ‘stitch’ together to make a single extended image.

1. To take a panoramic photo, select panoramic capture mode.
2. Align the camera to take a photo of one end of the panoramic scene (the furthest left, right, top or bottom).
3. Press the camera button to take the first image; then smoothly turn the camera to the left or right to take the next image of the scene.



Note: If fewer than five images are sufficient for your panoramic photo, tap the tick icon to stop the selection process and process the captured images.

The camera application will process the images and save a single extended image to your smartphone’s gallery.



Note: Panoramic images work best with static outdoor scenes. Objects too close to the camera or large straight edges may confuse the detection process.

Shooting a video

Turn on camcorder mode by tapping the camcorder icon.

1. Frame your subject and steady your smartphone and zoom in or out as needed.
2. Tap the record button to begin recording.

Supported formats

Type	Formats
Image	JPEG
Video	MPEG-4, H.263, H.264

Viewing and sharing photos and videos

After you have taken your photo or video, it is automatically saved.

Once you have taken a photo or video, you can view it in Gallery or share it on various services by tapping the thumbnail icon in the lower right corner. Alternatively, open the Applications tab and tap **Gallery**. From Gallery you can share the file directly using various services.



.....
Note: Share options vary depending on the file type.
.....

Advanced settings

Putting your smartphone in Airplane mode

You can enter Airplane mode (also known as flight mode) to turn off telephone and Bluetooth functions and use your smartphone as a handheld device during a flight. Check with your airline to make sure this is permitted onboard.

Switch your smartphone off during takeoff and landing as it may interfere with aircraft electronic systems.

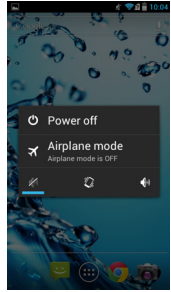

Turning Airplane mode on or off

1. Press and hold the power button until you get the phone options menu.
2. Tap **Airplane mode** to switch it ON or OFF.



.....
Note: When Airplane mode is active, the  icon will be displayed in the Notification area.
.....

Adjusting settings

This section will show you how to adjust detailed settings for your phone, data, Wi-Fi and Bluetooth connections.

Activating or deactivating connections

Open the Applications menu and tap **Settings** to manage your connection settings.

Item	Description
Wi-Fi	Turn the Wi-Fi function on or off.
Bluetooth	Turn the Bluetooth function on or off.
More...	Access additional connection settings.

Tap **More...** to access additional connection settings.

Item	Description
Airplane mode	Disable all wireless connections so you can safely use this device onboard an aircraft.
VPN settings	Set up and manage Virtual Private Networks.
Tethering & portable hotspot	Share your phone's mobile data connection via USB or as a portable Wi-Fi hotspot.
Wi-Fi direct	Turn the Wi-Fi Direct function on or off.
Wi-Fi direct settings	Set up and manage your Wi-Fi Direct devices.
Mobile networks	Set your options for connecting to mobile networks.



Important: If your phone is in Airplane mode, the option to turn Bluetooth on will be disabled. Please refer to "**Putting your smartphone in Airplane mode**" on page 33 for instructions on turning Airplane mode on or off.

Adjusting Bluetooth settings

You can use Bluetooth to exchange information between your smartphone and other mobile devices.

Bluetooth connections

For all Bluetooth settings, open the Applications menu and tap **Settings** > **Bluetooth**. Here you can switch Bluetooth on or off, set a device name and discoverability. Tap **SEARCH FOR DEVICES** to scan for available devices.

To connect to a device, tap the device in the list of available devices. You may be asked to enter a PIN on both devices to establish the connection.

Internet sharing

Tethering via USB

If you wish to share your mobile Internet connection with a computer, you can connect your phone to a PC using the supplied USB cable.

1. Plug the USB sync cable into the micro USB connector on your smartphone.
2. Plug the USB client connector into an available USB port on your computer.
3. Push the **Menu** button and then tap **Settings** > **More..** > **Tethering & portable hotspot** and then tap **USB tethering**.

Wi-Fi hotspot

You can turn your smartphone into a portable Wi-Fi hotspot to share your mobile Internet connection with up to 8 clients.

1. Push the **Menu** button and then tap **Settings** > **More...** > **Tethering & portable hotspot** > **Configure Wi-Fi hotspot**
2. Set the Network SSID and adjust security between Open and WPA2 PSK. Tap **Save** to finish.



Note: When your smartphone is serving as a Wi-Fi hotspot, you can't use your phone's applications to access the Internet via its Wi-Fi connection.

Phone network settings

In the Applications menu tap **Settings** > **More...** > **Mobile networks** to adjust your network settings. You can turn data connection on or off when roaming, choose a preferred network mode, specify a network operator and define access point names.

Selecting a network

Your phone will automatically detect your carrier/network settings when you insert a new SIM card. However, you may prefer to manually select a network. This may be a good idea when roaming.



Tip: When you are traveling, manually selecting a network may help to reduce your roaming charges. Check with your home service provider for the network offering the most competitive rates at your destination.

1. Open the Applications menu and tap **Settings > More... > Mobile networks > Network operators**.
2. Your phone will search for available networks.
3. Select your preferred network from the list generated. Your phone will attempt to register on the selected network.
4. Tap **Select automatically** to connect to the available network with the strongest signal. This may lead to your phone jumping between networks when you move around.



Note: Contact your service provider should you have any problems obtaining voice mail and the text message service center numbers.

Data usage control settings

Data usage controls let you monitor total usage by network type and application and then set limits if needed.

To access the Data usage settings, from the Application menu tap **Settings > Data usage**.



Note: To set a data limit, Wi-Fi or Mobile data must be enabled.

Sound

To adjust your phone's sound settings, in the Application menu tap **Settings > Sound**.

Item	Description
Volumes	Adjust the media, ringtone & notification, and alarm volumes.
Silent mode	Silence all sounds except media and alarms.
Phone ringtone	Sets your phone's ringtone.
Default notification	Set your phone's default notification sound.
Vibrate and ring	Set your phone to vibrate and ring when not in silent mode.
Dial pad touch tones	Play tones when using dial pad.
Touch sounds	Play sounds when touching certain UI elements.
Screen lock sound	Play sound when locking and unlocking the screen.
Vibrate on touch	Vibrate when pressing soft keys and on certain UI interactions.

Display

To adjust your phone's display settings, in the Application menu tap **Settings > Display**.

Item	Description
Brightness	Adjust screen brightness.
Wallpaper	Change the Home screen's wallpaper
Auto-rotate screen	Enable rotation of the screen when device is tilted.
Sleep	Adjust the delay before the screen automatically turns off.
Font size	Change the default font size for the UI.
Pulse notification light	Enable the notification light.

Phone settings

Many phone settings are automatically configured by your smartphone when you insert a SIM card. The device will communicate with your provider and automatically obtain all necessary settings, such as network name, voice mail and text message center numbers.

You can also view and modify these settings manually through the Call settings screen.

Open the Applications menu and tap **Settings > More... > Call settings**.

Connecting to a PC

If you wish to transfer information between the microSD card in your phone and your computer, you can connect your phone to a PC using the supplied USB cable. Plug the USB sync cable into the micro USB connector on your smartphone. Plug the USB client connector into an available USB port on your computer.

Pull down the notification bar, and tap **Connected as media device**, or **Connected as a camera** to configure the USB options.

You will now be able to see the microSD card in your phone as a drive in your computer's file explorer.

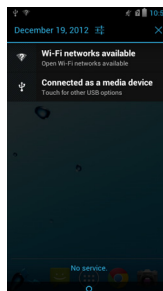

.....
Note: After turning on USB storage, you will not be able to access the files in the microSD card or applications such as Gallery or Music.
.....

Synchronization

You can sync your calendar, email and contacts on your phone and never worry about losing them again. Sync in real time or adjust it as you please. In the Applications menu tap **Settings** > **Accounts & sync** to access the synchronization settings.

To have your smartphone auto-sync, make sure **Accounts & sync** is set to **ON**.

To manage synchronization of individual accounts, tap an account to see their settings.

To add a new account, tap **ADD ACCOUNT**. Select the type of account (Corporate, Email, Facebook, or Google) and then follow on the on screen instructions.

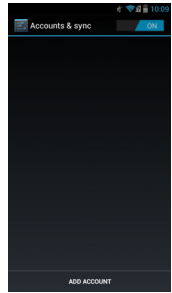

Google Sync

In Google, you can set synchronization for contacts, email, photos and calendar. In the Accounts & sync menu, tap on a Google account and then tap the checkmark next to the item you would like to have auto-sync. Tap again to uncheck any for manual synchronization.

To manually synchronize an item, make sure the item is checked, tap the **Menu** button and then tap **Sync now**.



.....
Note: You need a Google account to sync your calendar and appointments.
.....

FM radio

The FM radio allows you to listen to your favorite stations while on the move. Headphones must be inserted to the 3.5 mm jack as it functions as an antenna.

You can access the radio by tapping **FM Radio** from the Applications menu.

Tap the power button on the upper right corner to turn the radio off.

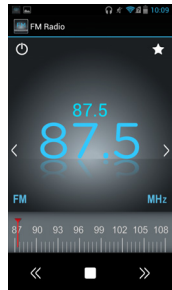

Multimedia playback

Your smartphone comes supplied with a variety of programs that you can use to enjoy multimedia content.

Media server

Your phone can act as a digital media server using uPnP technology. This means that you can use it to send media content to other uPnP-enabled home entertainment devices that are connected to a home wireless network.

To set up the media server, open the Applications menu and tap **Media server**.

You will need to enable **Share Contents** before you can start using the service.

Adjusting the volume

Adjust the volume of your phone using the volume button on the side of the phone. Alternatively, you can set the **Ringer volume** and **Media volume** by opening the Applications menu and tapping **Settings > Sound > Volumes**.

Setting the date and time

To set the date and time, open the Applications menu and tap **Settings > Date & time**.



.....
Tip: If you travel frequently or live in an area that uses daylight saving time, activate **Automatic date & time** from this menu. This will enable your smartphone to set the date and time based on information it receives from the network.
.....

Setting alarms

There are two predefined alarms on your phone by default. Tap **Clock** in the Applications menu, and then tap the alarm icon to edit alarm settings. You may:

- Turn the alarm on or off.
- Set the alarm time.
- Set which days to repeat the alarm.
- Set a ringtone.
- Enable or disable vibrate.
- Give it a label.

Changing language and text options

Set your location and language input preferences by opening the Applications menu and going to **Settings > Language & input**.

Managing applications

App-2-SD

When installing an application, you may have a choice to install the program to the internal memory or installed memory card.



.....
Note: Not all applications support App-2-SD. Please see application specifications for compatibility.
.....



.....
Warning! Make sure you trust the source of any application you install. If you are not sure of the source, do not install an application. Installing applications from unknown sources increases your risk of virus attacks and theft of personal and private data.
.....

Moving applications to the installed memory card

Once an application is installed, it may be possible to move it to the installed memory card to free up more space on the device's internal storage.

To move an application to the installed memory card:

1. In the Applications menu, tap **Settings > Apps**.
2. Tap on the **Downloaded** tab and then tap on the application you would like to move.
3. If it is possible to move the application, then you will be able to tap **Move to SD card**. If the option is greyed-out, then the application can not be moved. If you see the **Move to phone** option, then the application is already on SD card.



.....
Note: Not all applications can be moved to the external memory card.
.....

Closing an application

To close an active application, in the Applications menu tap **Settings > Apps**. Tap the **Running** tab, then tap the program you wish to close. Select **Stop** to close the program.

Uninstalling an application

You can remove programs installed on your smartphone to free up extra storage memory.

1. In the Applications menu tap **Settings > Apps**.
2. Click on the **Downloaded** tab.
3. Find the application in the list and tap on it.
4. Tap the **Uninstall** button and then tap **OK**. and hold a program icon from the Applications menu and drag it into the trash can on the bottom left hand corner.



.....
Warning! You should only remove programs if you are familiar with the Android operating system.
.....

Restoring to factory settings

You may perform a clean boot to restore your smartphone to the factory settings.



.....
Note: Before performing a clean boot, ensure that your smartphone is not locked. Press any key or tap the screen to see if the phone responds.
.....



.....
Warning! You should only perform a clean boot when all other options have failed to restore your smartphone to an operational state.
.....



.....
Warning! This will erase all your personal information, any contacts stored on your phone and any programs you installed.
.....

If your phone is responding to screen input, then open **Settings** from the Applications menu. Tap **Backup & reset > Factory data reset**; click **Reset phone** and then **Erase everything** to format your phone.

Accessories and tips

This chapter shows you how to use accessories with your smartphone, as well as provide useful tips for when you are using your smartphone.

Using the headset

Your smartphone comes packaged with a headset with built-in microphone for handsfree use when making calls.

To use the headset, plug it into the 3.5 mm headphone jack at the top of the phone.

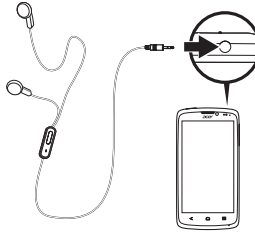

When the headset is plugged in, all audio is routed to the headset, and the speakers are turned off.

- To answer an incoming call, press the button on the microphone.
- Adjust the volume using the volume up/down button on the smartphone.
- End the call by pressing the button again.

Using a Bluetooth headset

Your smartphone's Bluetooth functions make it fully compatible with all Bluetooth headsets. This allows you to use the unit handsfree when making calls, without the inconvenience of wires.

Creating a new access point

When you need to add another GPRS/3G/EDGE connection on your phone, obtain the access point name and settings (including username and password if required) from your wireless service provider.

1. Open the Applications menu and tap **Settings** > **More...** > **Mobile networks** > **Access Point Names**.
2. Tap the **Menu** button and then tap **New APN**.
3. Enter the APN settings. Tap an item to adjust it.
4. When you have finished tap the **Menu** button and then tap **Save**.



.....
Important: Some providers and countries do not allow the use of a smartphone as a modem over HSDPA. Please check with your provider before attempting to do so.
.....

Inserting a microSD Card

Your smartphone features a memory expansion slot that accepts a microSD Card to expand memory and storage capacity.

Please refer to **"Installing a SIM or microSD card"** on page 6 for instructions on installing a microSD Card.

Appendix

FAQ and troubleshooting

This section lists frequently asked questions that may arise during the use of your smartphone, and gives easy answers and solutions to these questions.

Aspect	Question	Answer
Audio	Why is there no sound coming from the device?	If the headset is plugged into the device, the speaker is automatically shut off. Disconnect the headset. Check that the device volume setting is not muted. Check that the volume control is not at its lowest setting.
Multimedia files	Why can't I view my video files?	You may be trying to view a video that is not supported. Refer to "Multimedia" on page 48 .
	Why can't I play my music files?	You may be trying to play a file that is not supported. Refer to "Multimedia" on page 48 .
System information and performance	How do I check the OS version of my device?	Tap Apps > Settings > About phone to check the OS version (Build number) and other hardware and software information.
Power	I can't turn on the device.	The battery power may be depleted. Recharge the device. Refer to "Charging the battery" on page 7 for more information.
RAM / ROM	How do I check the RAM and ROM memory status?	To check the ROM status, press the Menu button and then tap System settings > Storage . To check RAM status, tap Apps > Settings > RUNNING .
Internal storage	My device's available internal storage is full or almost full.	Uninstall applications or move applications to the SD card to increase available storage. See "Managing applications" on page 38 .
Unlock pattern	I forgot my unlock pattern.	After a certain number of wrong entries, you will be presented with an option to reset your pattern. Tap Forgot pattern? and enter your google account username and password. Note: You must have an active Google account on the smartphone. Alternatively, you restore your smartphone to factory settings. See "Restoring to factory settings" on page 39 .

Aspect	Question	Answer
Heat	The phone heats up when charging or making long duration calls.	It is normal for the phone to heat up when charging. When charging is complete, it will return to its normal temperature. It is also normal for the phone to heat up during long periods of use, such as watching a video or a long phone conversation.

Other sources of help

For information on:	Refer to:
Up-to-date information regarding your smartphone	www.acer.com mobile.acer.com
Service enquiries	www.acer.com/support

Warnings and precautions

- Do not use this product near water.
- Do not place this product on an unstable cart, stand or table. If the product falls, it could be seriously damaged.
- Slots and openings are provided for ventilation to ensure reliable operation of the product and to protect it from overheating. These openings must not be blocked or covered. The openings should never be blocked by placing the product on a bed, sofa, rug or other similar surface. This product should never be placed near or over a radiator or heat register, or in a built-in installation unless proper ventilation is provided.
- Never push objects of any kind into this product through cabinet slots as they may touch dangerous voltage points or short-out parts that could result in a fire or electric shock. Never spill liquid of any kind onto or into the product.
- To avoid damage of internal components and to prevent battery leakage, do not place the product on a vibrating surface.
- Never use this product when engaging in sporting activities, exercising, or in any vibrating environment which may cause a short circuit or damage, and even a risk of explosion from the battery pack.

CAUTION when listening to music

To protect your hearing, follow these instructions.

- Increase the volume gradually until you can hear clearly and comfortably.
- Do not increase the volume level after your ears have adjusted.
- Do not listen to music at high volumes for extended periods.
- Do not increase the volume to block out noisy surroundings.
- Decrease the volume if you can't hear people speaking near you.

Battery information

This product uses a Lithium-ion battery. Do not use it in a humid, wet and/or corrosive environment. Do not put, store or leave your product in or near a heat source, in a high temperature location, in strong direct sunlight, in a microwave oven or in a pressurized container, and do not expose it to temperatures over 60 °C (140 °F). Failure to follow these

guidelines may cause the battery to leak acid, become hot, explode or ignite and cause injury and/or damage. Do not pierce, open or disassemble the battery. If the battery leaks and you come into contact with the leaked fluids, rinse thoroughly with water and seek medical attention immediately. For safety reasons, and to prolong the lifetime of the battery, charging will not occur at low (below 0° C/32° F) or high (over 40° C/104° F) temperatures.

The full performance of a new battery is achieved only after two or three complete charge and discharge cycles. The battery can be charged and discharged hundreds of times, but it will eventually wear out. When the talk and standby times are noticeably shorter than normal, buy a new battery. Use only Acer approved batteries, and recharge your battery only with Acer approved chargers designated for this device.

Unplug the charger from the electrical plug and the device when not in use. Do not leave a fully charged battery connected to the ac charger, since overcharging may shorten its lifetime. If left unused, a fully charged battery will lose its charge over time. If the battery is completely discharged, it may take a few minutes before the charging indicator appears on the display or before any calls can be made.

Use the battery only for its intended purpose. Never use any charger or battery that is damaged.

Do not short-circuit the battery. Accidental short-circuiting can occur when a metallic object such as a coin, clip, or pen causes direct connection of the positive (+) and negative (-) terminals of the battery. (These look like metal strips on the battery.) This might happen, for example, when you carry a spare battery in your pocket or purse. Short-circuiting the terminals may damage the battery or the connecting object.

Leaving the battery in hot or cold places, such as in a closed car in summer or winter conditions, will reduce the capacity and lifetime of the battery. Always try to keep the battery between 15° C and 25° C (59° F and 77° F). A device with a hot or cold battery may not work temporarily, even when the battery is fully charged. Battery performance is particularly limited in temperatures well below freezing.

Do not dispose of batteries in a fire as they may explode. Batteries may also explode if damaged. Dispose of batteries according to local regulations. Please recycle when possible. Do not dispose as household waste.

Replacing the battery pack

Your smartphone uses lithium batteries. Replace the battery with the same type as that which came bundled with your product. Use of another battery may present a risk of fire or explosion.



.....
Warning! Batteries may explode if not handled properly. Do not disassemble or dispose of them in fire. Keep them away from children. Follow local regulations when disposing of used batteries.
.....

Additional safety information

Your device and its enhancements may contain small parts. Keep them out of the reach of small children.

Operating environment



.....
Warning! For safety reasons, turn off all wireless or radio transmitting devices when using your smartphone device under the following conditions. These devices may include, but are not limited to: wireless LAN (WLAN), Bluetooth and/or 3G.
.....

Remember to follow any special regulations in force in any area, and always switch off your device when its use is prohibited or when it may cause interference or danger. Use the device only in its normal operating positions. To successfully transmit data files or messages, this device requires a good quality connection to the network. In some cases, transmission of data files or messages may be delayed until such a connection is available. Ensure that the above separation distance instructions are followed until the transmission is completed. Parts of the device are magnetic. Metallic materials may be attracted to the device, and persons with hearing aids should not hold the device to the ear with the hearing aid. Do not place credit cards or other magnetic storage media near the device, because information stored on them may be erased.

Medical devices

Operation of any radio transmitting equipment, including wireless phones, may interfere with the functionality of inadequately protected medical devices. Consult a physician or the manufacturer of the medical device to determine if they are adequately shielded from external RF energy or if you have any questions. Switch off your device in health care facilities when any regulations posted in these areas instruct you to do so. Hospitals or health care facilities may be using equipment that could be sensitive to external RF transmissions.

Pacemakers. Pacemaker manufacturers recommend that a minimum separation of 15.3 cm (6") be maintained between wireless devices and a pacemaker to avoid potential interference with the pacemaker. These recommendations are consistent with the independent research by and recommendations of Wireless Technology Research. Persons with pacemakers should do the following:

- Always keep the device more than 15.3 cm (6") from the pacemaker.
- Not carry the device near your pacemaker when the device is switched on. If you suspect interference, switch off your device, and move it.

Hearing aids. Some digital wireless devices may interfere with some hearing aids. If interference occurs, consult your service provider.

Vehicles

RF signals may affect improperly installed or inadequately shielded electronic systems in motor vehicles such as electronic fuel injection systems, electronic anti-skid (anti-lock) braking systems, electronic speed control systems, and air bag systems. For more information, check with the manufacturer, or its representative, of your vehicle or any equipment that has been added. Only qualified personnel should service the device, or install the device in a vehicle. Faulty installation or service may be dangerous and may invalidate any warranty that may apply to the device. Check regularly that all wireless equipment in your vehicle is mounted and operating properly. Do not store or carry flammable liquids, gases, or explosive materials in the same compartment as the device, its parts, or enhancements. For vehicles equipped with an air bag, remember that air bags inflate with great force. Do not place objects, including installed or portable wireless equipment in the area over the air bag or in the air bag deployment area. If in-vehicle wireless equipment is improperly installed, and the air bag inflates, serious injury could result. Using your device while flying in aircraft is prohibited. Switch off your device before boarding an aircraft. The use of wireless teledevices in an aircraft may be dangerous to the operation of the aircraft, disrupt the wireless telephone network, and may be illegal.

Potentially explosive environments

Switch off your device when in any area with a potentially explosive atmosphere and obey all signs and instructions. Potentially explosive atmospheres include areas where you would normally be advised to turn off your vehicle engine. Sparks in such areas could cause an

explosion or fire resulting in bodily injury or even death. Switch off the device at refueling points such as near gas pumps at service stations. Observe restrictions on the use of radio equipment in fuel depots, storage, and distribution areas; chemical plants; or where blasting operations are in progress. Areas with a potentially explosive atmospheres are often, but not always, clearly marked. They include below deck on boats, chemical transfer or storage facilities, vehicles using liquefied petroleum gas (such as propane or butane), and areas where the air contains chemicals or particles such as grain, dust or metal powders.

Follow any restrictions. Do not use the device where blasting is in progress.

Emergency calls

Important: Wireless phones, including this device, operate using radio signals, wireless networks, landline networks, and user-programmed functions. Because of this, connections in all conditions cannot be guaranteed. You should never rely solely on any wireless device for essential communications like medical emergencies.

If certain features are in use, you may first need to turn those features off before you can make an emergency call. Consult this guide or your service provider for more information.

When making an emergency call, give all the necessary information as accurately as possible. Your wireless device may be the only means of communication at the scene of an accident. Do not end the call until given permission to do so.

Taking care of your smartphone

1. **DO** take care not to scratch the screen of your smartphone. Keep the screen clean. When working with your smartphone, use your finger or fingernail. Never use an actual pen or pencil or other sharp object on the screen surface.
2. **DO NOT** expose your smartphone to rain or moisture. Do not let water enter the circuitry through the front panel buttons or expansion slots. In general, treat your smartphone as you would a mobile phone or other small electronic device.
3. **DO** be careful not to drop your smartphone or subject it to any strong impact. Do not place your smartphone in your back pocket.
4. **DO NOT** expose your smartphone to extreme temperatures. For example, do not leave your smartphone on the dashboard of a car on a hot day or when temperatures are below freezing point. Also, keep it away from heaters and other sources of heat.
5. **DO NOT** use or store your smartphone in any location that is dusty, damp or wet.
6. **DO** use a soft, damp cloth to clean your smartphone. If the surface of the screen becomes soiled, clean it with a soft cloth moistened with diluted window-cleaning solution.
7. **DO NOT** press down on the screen with force, otherwise you may crack the screen.

Specifications

Performance

- Intel Atom Processor Z2420
- System memory:
 - 1 GB of RAM
 - 4 GB of ROM
- Android operating system

Display

- 4.3" qHD IPS LCD, capacitive multi-touch screen
- 960 x 540 resolution

Multimedia

Formats supported:

Type	Formats
Audio playback	MP3, AMR
Ringtone	MP3, MIDI, iMelody, WAVE
Video recording	3GP, MPEG-4, H.263, H.264
Video playback	3GP, MPEG-4, H.263, H.264

USB connector

- Micro USB connector
- USB client
- DC power-in (5 V, 1 A)

Connectivity

- Bluetooth 2.1 + EDR
- IEEE Wi-Fi 802.11b/g/n WLAN
- GSM 850 / 900 / 1800 / 1900 MHz
- UMTS 850 / 900 / 1900 / 2100 MHz
- HSPA+ / GPRS / EDGE
- GPS
- AGPS

Camera

- 8-megapixel
 - Auto focus
 - LED flash
- Front camera

Expansion

- microSD memory card slot (up to 32 GB)

Battery

- Rechargeable high density 2000 mAh Lithium-ion battery (replaceable)



.....
Note: Length of battery operation will depend on power consumption which is based on system resource use. For example, constantly using the backlight or using power-demanding applications will shorten battery life between charges.
.....

Dimensions

Height	127.3 mm
Width	65.5 mm
Thickness	10 mm
Weight	140 g (with battery)

Safety

Battery information

This product uses a Lithium-ion battery. Do not use it in a humid, wet and/or corrosive environment. Do not put, store or leave your product in or near a heat source, in a high temperature location, in strong direct sunlight, in a microwave oven or in a pressurized container, and do not expose it to temperatures over 60 °C (140 °F). Failure to follow these guidelines may cause the battery to leak acid, become hot, explode or ignite and cause injury and/or damage. Do not pierce, open or disassemble the battery. If the battery leaks and you come into contact with the leaked fluids, rinse thoroughly with water and seek medical attention immediately. For safety reasons, and to prolong the lifetime of the battery, charging will not occur at low (below 0 °C/32 °F) or high (over 45 °C/113 °F) temperatures.

The full performance of a new battery is achieved only after two or three complete charge and discharge cycles. The battery can be charged and discharged hundreds of times, but it will eventually wear out. When the talk and standby times are noticeably shorter than normal, buy a new battery. Use only manufacturer approved batteries, and recharge your battery only with manufacturer approved chargers designated for this device.

Unplug the charger from the electrical plug and the device when not in use. Do not leave a fully charged battery connected to the AC charger, since overcharging may shorten its lifetime. If left unused, a fully charged battery will lose its charge over time. If the battery is completely discharged, it may take a few minutes before the charging indicator appears on the display or before any calls can be made.

Use the battery only for its intended purpose. Never use any charger or battery that is damaged.

Do not short-circuit the battery. Accidental short-circuiting can occur when a metallic object such as a coin, clip, or pen causes direct connection of the positive (+) and negative (-) terminals of the battery. These look like metal strips on the battery. This might happen, for example, when you carry a spare battery in your pocket or purse. Short-circuiting the terminals may damage the battery or the connecting object.

Leaving the battery in hot or cold places, such as in a closed car in summer or winter conditions, will reduce the capacity and lifetime of the battery. Always try to keep the battery between 15 °C and 25 °C (59 °F and 77 °F). A device with a hot or cold battery may not work temporarily, even when the battery is fully charged. Battery performance is particularly limited in temperatures well below freezing.

Do not dispose of batteries in a fire as they may explode. Batteries may also explode if damaged. Dispose of batteries according to local regulations. Please recycle when possible. Do not dispose as household waste.

Replacing the battery

Your smartphone uses a Lithium-ion battery. Replace the battery with the same type as that which came bundled with your product. Use of another battery may present a risk of fire or explosion.



Warning! Batteries may explode if not handled properly. Do not disassemble or dispose of them in fire. Keep them away from children. Follow local regulations when disposing of used batteries.

Disposal and recycling information



Do not throw this electronic device into the trash when discarding.



To minimize pollution and ensure utmost protection of the global environment, please recycle. For more information on the Waste from Electrical and Electronics Equipment (WEEE) regulations, visit **www.acer-group.com/public/Sustainability**

EEE yönetmeligine uygundur.

It is compliant with EEE regulation.

Regulatory information

Compliant with Russian regulatory certification



RoHS compliance

This product is in compliance with Directive 2011/65/EU of the European Parliament and of the Council of 8 June 2011, on the restriction of the use of certain hazardous substances (RoHS) in electrical and electronic equipment and its amendments.

Prevention of hearing loss



A pleine puissance, l'écoute prolongée du baladeur peut endommager l'oreille de l'utilisateur.



Note: For France, mobile headphones or earphones for this device have been tested to comply with the Sound Pressure requirement laid down in the applicable NF EN 50332-1:2000 and/or NF EN 50332-2:2003 standards as required by French Article L. 5232-1.



Caution: Permanent hearing loss may occur if earphones or headphones are used at high volume for prolonged periods of time.

Wireless operation channels for different domains

N. America	2.412-2.462 GHz	Ch01 through Ch11
Japan	2.412-2.484 GHz	Ch01 through Ch14
Europe ETSI	2.412-2.472 GHz	Ch01 through Ch13

List of National Codes

This equipment may be operated in the following countries:

Country	ISO 3166 2 letter code	Country	ISO 3166 2 letter code
Austria	AT	Malta	MT
Belgium	BE	Netherlands	NT
Cyprus	CY	Poland	PL
Czech Republic	CZ	Portugal	PT
Denmark	DK	Slovakia	SK
Estonia	EE	Slovenia	SL
Finland	FI	Spain	ES
France	FR	Sweden	SE
Germany	DE	United Kingdom	GB
Greece	GR	Iceland	IS
Hungary	HU	Liechtenstein	LI
Ireland	IE	Norway	NO
Italy	IT	Switzerland	CH
Latvia	LV	Bulgaria	BG
Lithuania	LT	Romania	RO
Luxembourg	LU	Turkey	TR

Certificate Information (SAR)

This device meets the EU requirements (1999/519/EC) on the limitation of exposure of the general public to electromagnetic fields by way of health protection.

The limits are part of extensive recommendations for the protection of the general public. These recommendations have been developed and checked by independent scientific organizations through regular and thorough evaluations of scientific studies. To guarantee the safety of all persons, regardless of age and health, the limits include a significant safety buffer.

Before radio devices can be put in circulation, their agreement with European laws or limits must be confirmed; only then may the CE symbol be applied.

The unit of measurement for the European Council's recommended limit for mobile telephones is the "Specific Absorption Rate" (SAR). This SAR limit is 2.0 W/kg, averaged over 10 g of body tissue. It meets the requirements of the International Commission on Non-Ionizing Radiation Protection (ICNIRP) and was included in the European Standard EN 50360 for mobile radio devices. The SAR regulation for mobile telephones is in line with European Standard EN 62209-1. The maximum SAR value is calculated at the highest output level in all frequency bands of the mobile telephone.

For body worn operation, this phone (EU model) has been tested and meets the ICNIRP exposure guidelines, and was included in the European Standard EN 62311 and EN 62209-2 for use with accessories that contain no metal and that position the handset a minimum of 1.5 cm from the body. Use of other accessories may not ensure compliance with ICNIRP exposure guidelines. If you do not use a body-worn accessory and are not holding the phone at the ear, position the handset a minimum of 1.5 cm from your body when the phone is switched on.

During use, the actual SAR level is usually much lower than the maximum value, because the mobile telephone works in different output levels. It only transmits with as much output as is required to reach the network. In general the following applies:

The closer you are to a base station, the lower the transmission output of your mobile telephone. The tested SAR of this device is as follows:

NCC	CE	
Head (W/kg)	Head (W/kg)	Body (W/kg)
0.375	0.369	0.702

NCC warning

警語

經型式認證合格之低功率射頻電機，非經許可，公司、商號或使用者均不得擅自變更頻率、加大功率或變更原設計之特性及功能。

低功率射頻電機之使用不得影響飛航安全及干擾合法通信；經發現有干擾現象時，應立即停用，並改善至無干擾時方得繼續使用。

前項合法通信，指依電信法規定作業之無線電通信。

低功率射頻電機須忍受合法通信或工業、科學及醫療用電波輻射性電機設備之干擾，減少電磁波影響，請妥善使用。



.....
Note: SAR 標準值 2.0 W/kg; 送測產品實測值為：0.375 W/kg
.....

Certification logos

To view the certification logos on your device: tap **Settings** > **About phone** > **Legal information** > **Certification logo**.

CE 0682



À pleine puissance, l'écoute prolongée du baladeur peut endommager l'oreille de l'utilisateur.

Lithium-ion battery warning

	<p>ATTENZIONE! Rischio di esplosione della batteria se sostituita in modo errato. Sostituire la batteria con un una di tipo uguale o equivalente consigliata dalla fabbrica. Non disperdere le batterie nell'ambiente.</p>
	<p>VORSICHT! Explosionsgefahr bei unsachgemäßen Austausch der Batterie. Ersatz nur durch denselben oder einem vom Hersteller empfohlenem ähnlichen Typ. Entsorgung gebrauchter Batterien nach Angaben des Herstellers.</p>
	<p>ADVARSEL!! Lithiumbatteri - Eksplosionsfare ved fejlagtig håndtering. Udskiftning må kun ske med batteri af samme fabrikat og type. Levér det brugte batteri tilbage til leverandøren.</p>
	<p>VARNING! Explosionsfara vid felaktigt batteribyte. Använd samma batterityp eller en ekvivalent typ som rekommenderas av apparattillverkaren. Kassera använt batteri enligt fabrikantens instruktion.</p>
	<p>VAROITUS! Paristo voi räjähtää, jos se on virheellisesti asennettu. Vaihda paristo ainoastaan laitevalmistajan suositttelemaan tyyppiin. Hävitä käytetty paristo valmistagan ohjeiden mukaisesti.</p>
	<p>ATTENTION! Il y a danger d'explosion s'il y a remplacement incorrect de la batterie. Remplacer uniquement avec une batterie du même type ou d' un type équivalent recommandé par le constructeur. Mettre au rebut les batteries usagées conformément aux instructions du fabricant.</p>
	<p>ADVARSEL! Eksplosjonsfare ved feilaktig skifte av batteri. Benytt samme batteritype eller en tilsvarende type anbefalt av apparatfabrikanten. Brukte batterier kasseres i henhold til fabrikantens instruksjoner.</p>

Declaration of Conformity

We, Acer Incorporated,
of 8F., No. 88, Sec. 1, Xintai 5th Rd., Xizhi Dist, New Taipei City, 22181, Taiwan

Declare under sole responsibility that the product:

Model: I110
Description: Smart Handheld

To which this declaration relates, is in conformity with the following standards and/or other normative documents:

- EN 301 511 V9.0.2
- EN 301 908-1 V5.2.1; EN 301 908-2 V5.2.1
- EN 300 328 V1.7.1
- EN 300 440-1 V1.6.1; EN 300 440-2 V1.4.1
- EN 301 489-1 V1.9.2; EN 301 489-3 V1.4.1; EN 301 489-7 V1.3.1
- EN 301 489-17 V2.2.1; EN 301 489-24 V1.5.1
- EN 55022:2010/AC:2011 Class B; EN 55024:2010
- EN 55013:2001/A1:2003/A2:2006; EN 55020:2007/A11:2011
- EN 60950-1: EN 60950-1:2006+A11:2009+A1:2010+A12:2011
- EN 50332-1:2000; EN 50332-2:2003
- EN 50360:2001/A1:2012; EN 62311:2008; EN 62209-1:2006;EN 62209-2:2010; EN 62479:2010
- EN 50581:2012
- RoHS Directive 2011/65/EU on the Restriction of Use of certain Hazardous Substances in Electrical and Electronic Equipment.

We hereby declare that the above named product is in conformance to all the essential requirements of the R&TTE Directive (99/5/EC) issued by the Commission of the European Community.

The conformity assessment procedure referred to in Article 10 and detailed in Annex [IV] of directive 1999/5/EC has been followed related to Articles:

- R&TTE Article 3.1 (a) Health and Safety
- R&TTE Article 3.1 (b) EMC
- R&TTE Article 3.2 Spectrum Usage

with the involvement of the following Notified Body:

CETECOM, Untertuerkheimer Str. 6 – 10 66117 Saarbruecken

Identification mark: **0682** (Notified Body) **CE**

The technical documentation relevant to the above equipment will be held at:

Acer Incorporated

8F., No. 88, Sec. 1, Xintai 5th Rd., Xizhi Dist, New Taipei City, 22181, Taiwan

Authorized person:

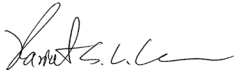

Name: Harriot SL Lee

For the address/telephone number of Acer service center, please refer to the warranty card.

End User License Agreement

IMPORTANT-READ CAREFULLY: THIS END USER LICENSE AGREEMENT ("AGREEMENT") IS A LEGAL AGREEMENT BETWEEN YOU (EITHER AN INDIVIDUAL OR A SINGLE ENTITY), AND ACER INC. INCLUDING ITS SUBSIDIARIES ("ACER") FOR THE SOFTWARE (WHETHER PROVIDED BY ACER OR BY ACER'S LICENSORS OR SUPPLIERS) THAT ACCOMPANIES THIS AGREEMENT, INCLUDING ANY ASSOCIATED MEDIA, PRINTED MATERIALS AND RELATED USER ELECTRONIC DOCUMENTATION WHICH MAY BE BRANDED "ACER" ("SOFTWARE"). AGREEMENTS RELATING TO ANY OTHER PRODUCT OR TOPIC ARE NEITHER INTENDED NOR SHOULD THEY BE IMPLIED. BY INSTALLING THE ACCOMPANYING SOFTWARE OR ANY PORTION THEREOF, YOU AGREE TO BE BOUND BY THE TERMS AND CONDITIONS OF THIS AGREEMENT. IF YOU DO NOT AGREE TO ALL OF THE TERMS AND CONDITIONS OF THIS AGREEMENT, DO NOT CONTINUE THE INSTALLATION PROCESS AND IMMEDIATELY DELETE ALL INSTALLED FILES, IF ANY, OF THE ACCOMPANYING SOFTWARE FROM YOUR PHONE.

IF YOU DO NOT HAVE A VALIDLY-LICENSED COPY OF THE APPLICABLE SOFTWARE, YOU ARE NOT AUTHORIZED TO INSTALL, COPY OR OTHERWISE USE THE SOFTWARE, AND HAVE NO RIGHTS UNDER THIS AGREEMENT.

The Software is protected by U.S. and international copyright laws and conventions as well as other intellectual property laws and treaties. The Software is licensed, not sold.

GRANT OF LICENSE

Acer grants to you the following non-exclusive and non-transferable rights with respect to the Software. Under this Agreement, you may:

1. Install and use the Software only on a single designated phone. A separate license is required for each phone on which the Software will be used;
2. Make one copy of the Software solely for backup or archival purposes;
3. Make one hardcopy of any electronic documents included in the Software, provided that you receive the documents electronically.

RESTRICTIONS

You may NOT:

1. Use or copy the Software except as provided in this Agreement;
2. Rent or lease the Software to any third party;
3. Modify, adapt, or translate the Software in whole or in part;
4. Reverse engineer, decompile, or disassemble the Software or create derivative works based upon the Software;
5. Merge the Software with any other program or modify the Software, except for your personal use; and
6. Sublicense or otherwise make the Software available to third parties, except that you may, after prior written notification to Acer, transfer the Software as a whole to a third party so long as you do not retain any copies of the Software and such third party accepts the terms of this Agreement.
7. Transfer your rights under this Agreement to any third parties.
8. Export the Software in contravention of applicable export laws and regulations, or (i) sell, export, re-export, transfer, divert, disclose technical data, or dispose of, any Software to any prohibited person, entity, or destination including, without limitation, Cuba, Iran, North Korea, Sudan and Syria; or (ii) use any Software for any use prohibited by the laws or regulations of the United States.

SUPPORT SERVICES

Acer is not obligated to provide technical or other support for the Software.

ACER LIVE UPDATE

Certain of the software contains elements that enable the use of the Acer Live Update service, which allows for updates for such software to be automatically downloaded and installed on your phone. By installing the software, you hereby agree and consent that Acer (or its licensors) may automatically check the version of such software that you are using on your phone and may provide upgrades to such software that may be automatically downloaded on to your phone.

OWNERSHIP AND COPYRIGHT

Title, ownership rights and intellectual property rights in and to the Software and all copies thereof shall remain with Acer or Acer's licensors or suppliers (as applicable). You do not have or shall not gain any proprietary interest in the Software (including any modifications or copies made by or for you) or any related intellectual property rights. Title and related rights in the content accessed through the Software is the property of the applicable content owner and may be protected by applicable law. This license gives you no rights to such contents. You hereby agree

1. Not to remove any copyright or other proprietary notices from the Software;
2. To reproduce all such notices on any authorized copies you make; and
3. To use best efforts to prevent any unauthorized copying of the Software.

TRADEMARKS

This Agreement does not grant to you any rights in connection with any trademarks or service marks of Acer or of Acer's licensors or suppliers.

DISCLAIMER OF WARRANTIES

TO THE MAXIMUM EXTENT PERMITTED BY APPLICABLE LAW, ACER, ITS SUPPLIERS, AND ITS LICENSORS, PROVIDE THE SOFTWARE "AS IS" AND WITH ALL FAULTS, AND HEREBY DISCLAIM ALL OTHER WARRANTIES AND CONDITIONS, EITHER EXPRESS, IMPLIED OR STATUTORY, INCLUDING, BUT NOT LIMITED TO, ANY IMPLIED WARRANTIES, DUTIES OR CONDITIONS OF MERCHANTABILITY, OF FITNESS FOR A PARTICULAR PURPOSE, OF ACCURACY OR COMPLETENESS OF RESPONSES, OF RESULTS, OF WORKMANLIKE EFFORT, OF LACK OF VIRUSES, AND OF LACK OF NEGLIGENCE, ALL WITH REGARD TO THE SOFTWARE AND THE PROVISION OF OR FAILURE TO PROVIDE SUPPORT

SERVICES. ALSO, THERE IS NO WARRANTY OR CONDITION OF TITLE, QUIET ENJOYMENT, QUIET POSSESSION, CORRESPONDENCE TO DESCRIPTION OR NON-INFRINGEMENT WITH REGARD TO THE SOFTWARE.

EXCLUSION OF INCIDENTAL, CONSEQUENTIAL AND CERTAIN OTHER DAMAGES

TO THE MAXIMUM EXTENT PERMITTED BY APPLICABLE LAW, IN NO EVENT SHALL ACER, ACER'S SUPPLIERS, OR ACER'S LICENSORS, BE LIABLE FOR ANY SPECIAL, INCIDENTAL, INDIRECT, PUNITIVE, OR CONSEQUENTIAL DAMAGES WHATSOEVER (INCLUDING, BUT NOT LIMITED TO, DAMAGES FOR LOSS OF PROFITS OR CONFIDENTIAL OR OTHER INFORMATION, FOR BUSINESS INTERRUPTION, FOR PERSONAL INJURY, FOR LOSS OF PRIVACY, FOR FAILURE TO MEET ANY DUTY INCLUDING OF GOOD FAITH OR OF REASONABLE CARE, FOR NEGLIGENCE, AND FOR ANY OTHER PECUNIARY OR OTHER LOSS WHATSOEVER) ARISING OUT OF OR IN ANY WAY RELATED TO THE USE OF OR INABILITY TO USE THE SOFTWARE, THE PROVISION OF OR FAILURE TO PROVIDE SUPPORT SERVICES, OR OTHERWISE UNDER OR IN CONNECTION WITH ANY PROVISION OF THIS AGREEMENT, EVEN IN THE EVENT OF THE FAULT, TORT (INCLUDING NEGLIGENCE), STRICT LIABILITY, BREACH OF CONTRACT OR BREACH OF WARRANTY OF ACER OR ITS SUPPLIERS OR LICENSORS, AND EVEN IF ACER AND ITS SUPPLIERS AND LICENSORS HAVE BEEN ADVISED OF THE POSSIBILITY OF SUCH DAMAGES.

LIMITATION OF LIABILITY AND REMEDIES

NOTWITHSTANDING ANY DAMAGES THAT YOU MIGHT INCUR FOR ANY REASON WHATSOEVER (INCLUDING, WITHOUT LIMITATION, ALL DAMAGES REFERENCED ABOVE AND ALL DIRECT OR GENERAL DAMAGES), THE ENTIRE LIABILITY OF ACER, ITS SUPPLIERS, AND ITS LICENSORS, UNDER ANY PROVISION OF THIS AGREEMENT, AND YOUR EXCLUSIVE REMEDY FOR ALL OF THE FOREGOING, SHALL BE LIMITED TO THE AGGREGATE AMOUNT PAID BY YOU FOR THE SOFTWARE. THE FOREGOING LIMITATIONS, EXCLUSIONS AND DISCLAIMERS (INCLUDING DISCLAIMER OF WARRANTIES AND EXCLUSION OF INCIDENTAL, CONSEQUENTIAL AND CERTAIN OTHER DAMAGES ABOVE) SHALL APPLY TO THE MAXIMUM EXTENT PERMITTED BY APPLICABLE LAW, EVEN IF ANY REMEDY FAILS ITS ESSENTIAL PURPOSE; PROVIDED, HOWEVER, THAT BECAUSE SOME JURISDICTIONS DO NOT ALLOW THE EXCLUSION OR LIMITATION OR LIABILITY FOR CONSEQUENTIAL OR INCIDENTAL DAMAGES, THE ABOVE LIMITATION MAY NOT APPLY TO YOU.

TERMINATION

Without prejudice to any other rights, Acer may immediately terminate this Agreement without notice if you fail to comply with any terms and conditions of this Agreement.

In such event, you must:

1. Cease all use of the Software;
2. Destroy or return to Acer the original and all copies of the Software; and
3. Delete the Software from all phones on which it was resident.

All disclaimers of warranties and limitation of liability set forth in this Agreement shall survive termination of this Agreement.

GENERAL

This Agreement represents the complete agreement between you and Acer relating to this license for the Software and supersedes all prior agreements, communications, proposals and representations between the parties and prevails over any conflicting or additional terms of any quote, order, acknowledgement or similar communication. This Agreement may only be modified by a written document signed by both parties. If any provision of this Agreement is held by a court of competent jurisdiction to be contrary to law that provision will be enforced to the maximum extent permissible and the remaining provisions of this Agreement will remain in full force and effect.

ADDITIONAL PROVISIONS APPLICABLE TO THIRD PARTY SOFTWARE AND SERVICES

Software provided hereunder by Acer's licensors or suppliers ("Third Party Software") is made available to you for your personal, non-commercial use only. You may not use the Third Party Software in any manner that could damage, disable, overburden, or impair the services provided by Acer's licensors or suppliers hereunder ("Third Party Services"). Furthermore, you may not use the Third Party Software in any manner that could interfere with any other party's use and enjoyment of the Third Party Services, or the services and products of Acer's licensors' or suppliers' third party licensors. Your use of the Third Party Software and Third Party Services is also subject to additional terms and conditions and policies which can be accessed through our global website.

Privacy policy

During registration you will be asked to submit some information to Acer. Please refer to Acer's privacy policy at www.acer.com or your local Acer website.